

Facility and Equipment Grounding to Enhance Equipment Performance 2011

Course: PQ-GND204

Presented by:

PowerCET Corporation
3350 Scott Blvd. Bldg. 55 Unit 1
Santa Clara, CA 95054
408/988-1346 | Fax 408/988-4869
E-mail: training@powercet.com
URL: <http://www.powercet.com>



Grounding

- **Earthing (European convention)**
 - Establishing a bond to earth at the facility service entrance for the electrical distribution system.
- **Grounding (U.S. convention)**
 - Establishing fault clearing paths within a facility for the electrical distribution system and for equipment within the facility.
- **Referencing**
 - Establishing a chassis contact to an external point to limit voltage rise.



Vs





The Equipment Ground Connection

- DC return referenced to chassis
- Chassis bonded to safety ground

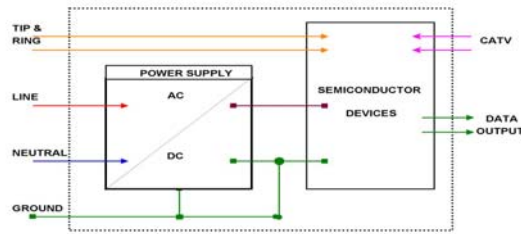

Grounding Concepts & References

- The effects of impedance & frequency
- Faraday cage & Kirchoff's Voltage and Current Laws
- National Electrical Code

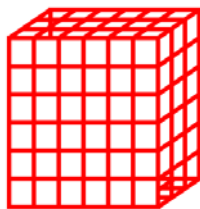



What Drives PQ Inspections?

- Ground resistance measurements required for new construction
- Equipment problems
- Nuisance GFI (ground fault interrupt)
- Communications problems
- Lighting problems
- Lightning problems
- “If it’s not power quality – then it must be grounding.”



Common Grounding Issues

- There isn’t any grounding.
- There is too much “grounding”.
- The grounding is misapplied.
- There are some serious/stupid wiring problems.
- The equipment is really the problem
 - Power frequency leakage currents
 - EMI/RFI.



Origins For Grounding Concepts

- **Electrical code**
 - Single point grounding
 - Fault path to electrical service
- **Telecommunications grounding**
 - Traditional DC grounding practices
 - Ground start & signaling
- **RF grounding**
 - Antenna grounding
- **Isolated grounding**
 - U.S. practice



"Earthing" Systems

- Three or four letter designation
- First letter is supply earthing
 - T indicates one or more points directly earthed
 - I indicates the supply is not earthed or is earthed through a fault limiting impedance
- Second letter indicates installation earthing
 - T indicates that conductive metalwork is directly connected to earth
 - N indicates that conductive metalwork is directly connected to the earthed neutral.
- US convention is TN -- not TT or IT
- Third and fourth letter describes earthed conductor arrangement
 - S indicates separate neutral and earthed conductors
 - C indicates combined neutral and earth conductor
- TN-S: consumers earth terminal connected to the supply protective conductor
- TN-C: consumers neutral and protective functions (ground) in a single conductor
- TN-C-S: consumers supply neutral and protective functions (ground) are combined and earthed



Earthing (Grounding) Systems

IT Earthing System

Utility not earthed or earthed via impedance
 Facility earthed independently of utility

TT Earthing System

Utility directly earthed
 Facility earthed independently of utility

TN Earthing System

Utility directly earthed (and frequently in US)
 Facility grounding bonded to earthed utility

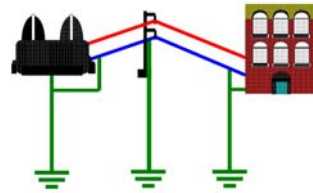
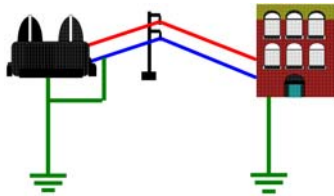
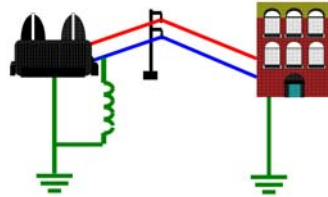

Soil Conditions



Soil Type vs Resistivity

- IEEE Std. 142-1991
 - Grounding of Industrial and Commercial Power Systems

Soil Type	Average Resistivity Ohms per CM	5/8" x 10' Driven Rod Ohms Resistance
Well graded gravel, gravel-sand	60,000 -- 100,000	180 -- 300
Loose gravel, gravel-sand	100,000 -- 250,000	300 -- 750
Clayey gravel, sand-clay	20,000 -- 40,000	60 -- 120
Silty sands, sand-silts mixtures	10,000 -- 50,000	30 -- 150
Clayey sands, sand-clay mixtures	5,000 -- 20,000	15 -- 60
Silty or clayey fine sands w/plasticity	3,000 -- 8,000	9 -- 24
Fine sandy or silty soils, elastic silts	8,000 -- 30,000	24 -- 90
Gravelly clays, sandy clays, silty clays, lean clays	2,500 -- 6,000 (moisture related)	17 -- 18 (moisture related)
Inorganic clays, high plasticity	1,000 -- 5500 (moisture related)	3 -- 16 (moisture related)



Soil Resistivity Vs Water Content 1

- IEEE Std. 142-1991

Moisture Content (by weight)	Resistivity Ohms/cm Sandy Loam
2	185,000
4	60,000
6	38,000
8	28,000
10	22,000
12	17,000
14	14,000
16	12,000
18	10,000
20	9,000
22	8,000
24	7,000



Effects of Moisture Content

▪ 8 Foot Rod

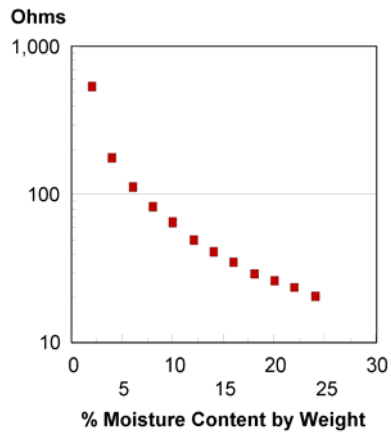

▪ Sandy Loam

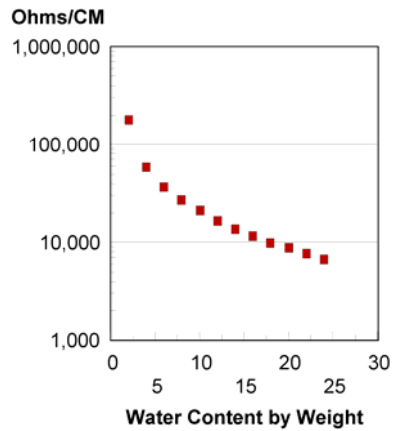

Soil Resistivity vs Temperature

▪ IEEE Std. 142-1991 (Green Book)

Temperature (centigrade)	Temperature (Fahrenheit)	Resistivity Ohms/cm
-5	23	70,000
0	32	30,000
0	32	10,000
10	50	8,000
20	68	7,000
30	86	6,000
40	104	5,000
50	122	4,000



Effects of Temperature

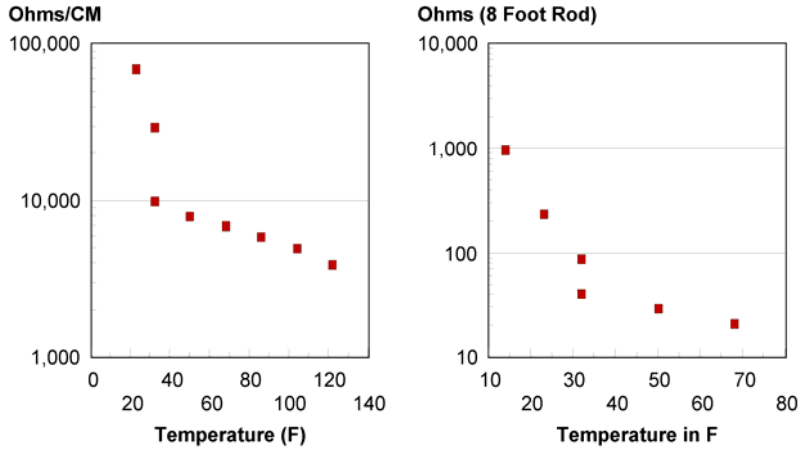

Soil Resistivity vs Salt Content

- Soil type -- sandy loam - moisture content 15% by weight -- temperature - 17°C
- Salts (copper sulfate, sodium carbonate etc.) must be EPA or local ordinance approved for use
- AEMC -- *Understanding Ground Resistance Testing*

Added Salt % by weight of moisture	Resistivity Ohms/centimeter
0	10700
0.1	1,800
1.0	450
5	190
10	130
20	100



Electrode Grounding Resistance

- NEC
 - 25 Ohms or supplement
 - NEC 250-56 [2005]
 - NEC 250.53(A)(2) Exception [2011]
- Health Care
 - IEEE Std. 602-1996 (White)
 - Section (10.4.5.2)
 - No more than 10 ohms
 - 5 Ohms or less preferred
- Industrial Plants
 - ANSI/IEEE Std. 141-1986 (RED)
 - Section 7.5.2
 - 1 ohm or less for substations
 - 5 ohms or less for industrial plants
- Sphere of influence
 - Radius equals length of buried rod

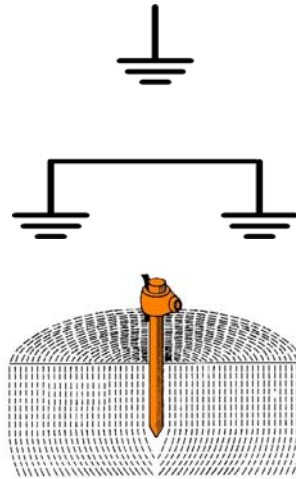

Grounding Sphere of Influence

- Common Grounding Electrode
 - NEC 250.58 [2011]
 - Parallel ground rods considered a single grounding electrode
 - Multiple services serving the same facility must use the same grounding electrode(s).
- Radius < length
 - Combined resistance
- Rod length
 - No less than 8 feet (2.5m)
 - NEC 250.52(A)(5) [2011]

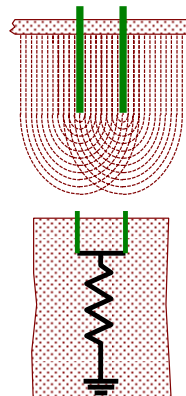

Grounding Sphere of Influence (2)

- 6 foot minimum separation
 - NEC-250-53(A)(3) [2011]
- Local codes may specify ground rod separation
- IEEE Std. 142-1991 (Green Book)
 - Grounding of Industrial and Commercial Power Systems
 - Table 13 --provides resistance calculation methods

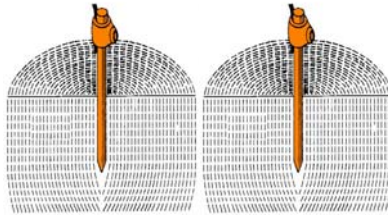

Grounding Protection?





Chemical Treatments

- Soil treatment
- Specialized system
 - Bentonite (kitty litter)
 - Calsolite (salts)
- Open systems
 - Local requirements
 - EPA impact

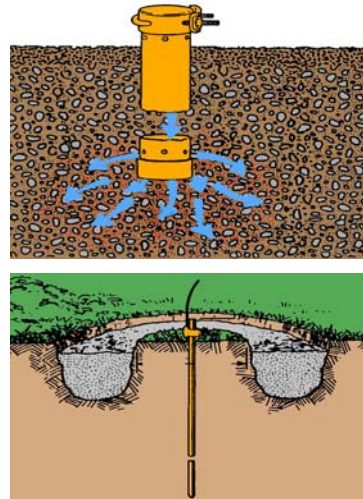

Electrolysis

- Electrochemical series
- Galvanic Battery

→	Magnesium (-2.34V)
→	Aluminum (-1.67V)
→	Iron (-0.44V)
→	Tin (-0.14)
→	Copper (+0.34V)
→	Stainless Steel
→	Gold (+1.42V)

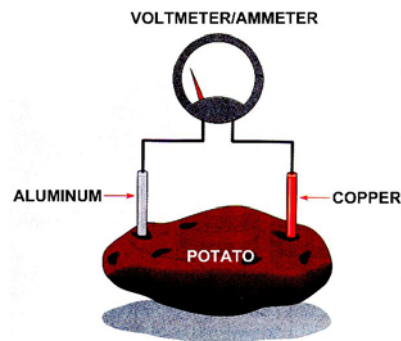



Measuring Electrode Resistance



Made Electrode Earth Resistance

- NEC 250.53 Grounding Electrode System Installation
- NEC 250.53(A)(2) [2011]
 - A single rod, pipe or plate electrode shall be supplemented by an additional electrode of a type specified in 250.52(A)(2) through (A)(8).
- NEC 250.53(A)(2) Exception [2011]
 - “If a single rod, pipe or plate grounding electrode has a resistance to earth of 25 ohms or less, the supplemental electrode shall not be required.”



Grounding Measurements - 3 Pt.

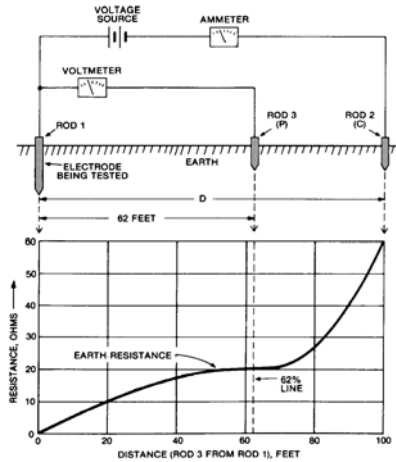

3 Pt. Measurement Complications

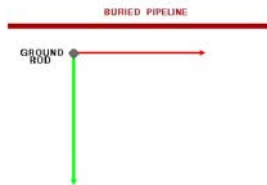

Earth Ground Resistance Testing for Low Voltage Power Systems
 Kenneth M. Michaels
 IEEE Transactions - Industry Applications
 Jan/Feb 1995

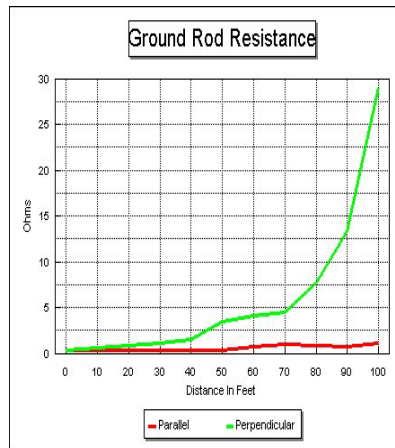



2 Pt. Clamp-on Measurements

- Designed for use with power poles
- Common neutral/ground connections provides essentially an "infinite" ground connection
- Measurement reflect attachment point versus all utility ground connections

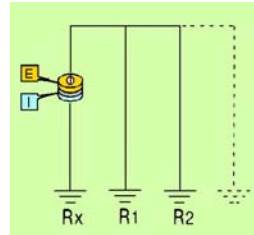

Clamp-On Complications

- Four separate measurement points
- Results vary from 2.8 Ohms to >1990 ohms
- Variable results caused by loop inductance/resonance

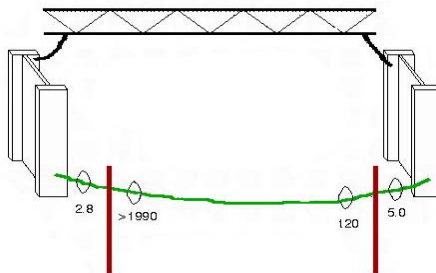

Earth Ground Resistance Testing for Low Voltage Power Systems
Kenneth H. Michael
IEEE Transactions - Industry Applications Jan/Feb 1995



Four Point Resistivity Measurement

- Undisturbed native soil necessary
- Current injected between C1 and C2 with voltage measured from P1 to P2.

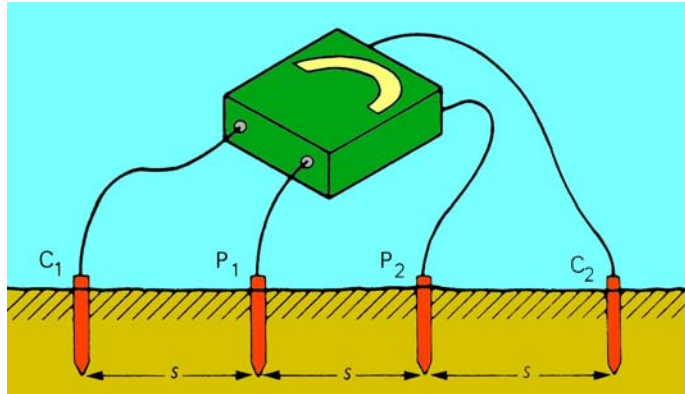

Earthing & Grounding

- General
 - NEC 250 I [2011]
- System Grounding
 - NEC 250 II [2011]
- Grounding Electrode System
 - NEC 250 III [2011]



The Roles of Grounding

- General requirements
 - NEC 250.4 [2011]
 - Establish voltage reference
 - Limit touch potential
 - Clear electrical faults
 - Carry lightning currents
- Performance issues
 - Provide equipment reference
 - Provide RF/ESD discharge path

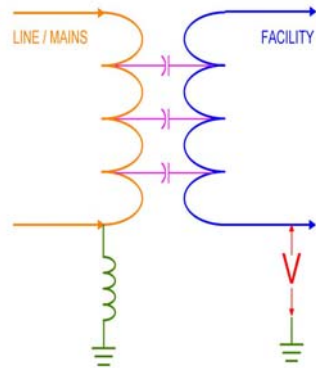

Grounding Electrode System (GES)

- National Electrical Code Article 250
 - **Electrical service entrance bonding**
 - NEC 250-20 [2011]
 - Incoming utility neutral or internal facility neutral
 - **Grounding electrode system** –
 - NEC 250.50 [2011]
 - Structural steel where effectively grounded
 - "All grounding electrodes as described in 250.52(A)(1) through (A)(7) that are present at each building or structure served shall be bonded together to form the grounding electrode system."
 - Ufer grounds (concrete encased electrode)
 - Building footings if designed as Ufer grounds
 - Water pipes
 - Ground ring
 - Plate electrodes
 - Driven grounding rods





Grounding Electrode System

- GES - NEC 250-50 [2011]
 - Water Pipe - NEC 250.52(A)(1)
 - Driven Ground - NEC 250.52(A)(5)
 - Structural Steel - NEC 250.52(A)(2)
- Water Pipe must be supplemented
 - NEC 250.53(D)(2) [2011]
- Grounding electrode conductor must be continuous
 - NEC 250.64(C) [2011]
- Not allowed
 - Metal underground gas pipes
 - Aluminum electrodes
 - NEC 250.52(B) [2011]

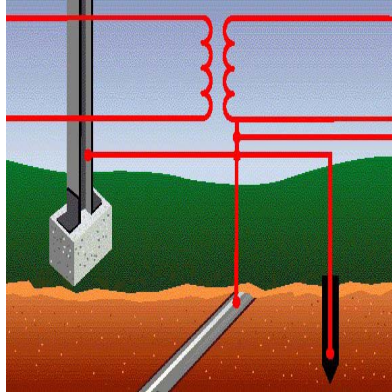

Bonds to Water Pipes

- Underground water pipe cannot be the sole grounding means
 - NEC 250.53(D)(2) [2011]
 - Must be supplemented by a made electrode
- Bond within 5' of point of entry
 - NEC 250.68(C)(1) [2011]
- Connection Quality???





Water Meters & the GES

▪ Metering

- Must not impede grounding path
- NEC 250.68(B) [2011]



Gas Pipes

▪ Underground gas pipes

- “shall not be used as grounding electrodes”
- NEC 250.52(B)(1) [2011]

▪ Gas pipes inside facility

- Bonding after shutoff valve
- “If installed in, or attached to, a building or structure, a metal piping system(s), including gas piping, that is likely to become energized shall be bonded to the service equipment enclosure; the grounded conductor at the service; the grounding electrode conductor, if of sufficient size; or to one or more of the grounding electrodes used.”
- NEC 250.104(B) [2011]
- The problem lies with the term “likely.”



Faults to CSST

- Multiple adjacent holes of similar size
 - Frequently reported from indirect lightning
 - Adjacent arcs unlikely to exist concurrently
 - Likely serial from multiple-stroke lightning flash
 - Power system only source likely to deliver similar energy in successive arcs
 - CSST = Corrugated stainless steel tubing



CSST Arc Damage Mechanisms

- Direct Lightning Strikes
 - Fraction of lightning current flows onto CSST through arc
 - Return stroke
 - Continuing current
 - Sufficient current magnitude and duration to cause observed damage
- Indirect Lightning Strikes
 - Indirect lightning currents too small and too short duration to damage CSST
 - Indirect overvoltage (> 50 kV) causes multiple flashovers, including AC power system
 - AC power fault current flows through arc
 - Sufficient current magnitude and duration to cause observed damage
 - Power fault currents also likely cause of many fires not involving gas pipes



Solutions to Gas Pipe Damage

- Direct Strikes
 - Install at least minimal lightning protection system
 - Bond all metal services to main building and power system ground
 - Including gas pipes on building side of service
 - All gas pipes, not just CSST!
- Indirect Strikes
 - Ground ungrounded roof penetrations
 - Preferably through lightning protection system
 - Bond all metal services to main building and power system ground
 - Including gas pipes on building side of service
 - Evaluate benefit of earth-leakage relays on AC power system



Grounding Connections 2005

- NEC 250.8 [2005]
 - "Grounding conductor and bonding jumpers shall be connected by exothermic welding, listed pressure connectors, listed clamps, or other listed means. Connection devices or fittings that depend solely upon solder shall not be used. Sheet metal screws shall not be used to connect grounding conductors or connections devices to enclosures."





Grounding Connections 2011

- Recognized attachment methods
 - NEC 250.8(A) [2011]
 - Exothermic
 - Clamp
 - Listed pressure connectors
 - Machine type or thread forming screws with at least two threads for contact (sheet metal screws not included)
- Sole use of solder not allowed
 - NEC 250.8(B) [2011]



Grounding Conductor Bonding

- Bond grounding conductor to both ends
 - NEC 250.64(E) [2011]
 - Connections must be clean and permanent
 - No sheet metal screws





Protecting Against Corrosion

- Protection of clamps and fittings
 - NEC 250.10 [2011]
- Clean surfaces
 - NEC 250.12 [2011]
 - Remove paint, varnish etc.
- If not resistant - Protection from corrosion
 - NEC 250.62 [2011]
- Kopr-Shield Compound
 - Slurry of copper
 - Anti-corrosive



Facility Grounding & Structural Continuity



Types of Grounding Electrodes

- Driven ground rods
 - Copper clad steel
- Plate electrode
 - Two square feet minimum - 1/4 inch thick steel (6.35mm) - 21/2' depth
- Ring ground
 - Grounding conductor buried around building perimeter
- Chemical grounds
 - Traditional rod or ring with chemical treatment
 - Specializing ground rod with integral chemical treatment
- Concrete encased electrode (Ufer ground & GRIF)
 - Metallic conductor embedded in structural concrete



Ground Ring

- Ground ring
 - NEC 250.52(A)(4) [2011]
 - Buried at least 2.5' (762mm)
 - At least 20' long
 - No smaller than No. 2 gauge
- Augmented ring
 - Driven rods
 - Surface radials
 - Bond to structural steel
 - At corners
 - At regular intervals

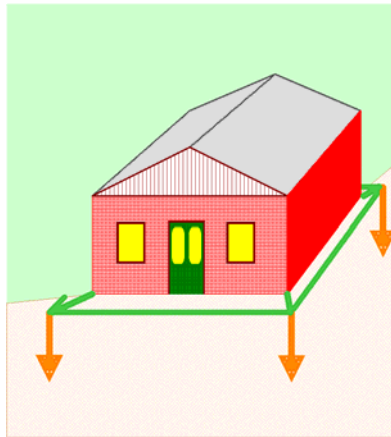



Concrete Encased Electrode

- Concrete encased electrode (Ufer ground)
 - NEC250.52(A)(3) [2011]
 - At least 20 feet (6.1m) of zinc galvanized conductor or steel reinforcing bar not less than 1/2 inch or 20 feet of bare No. 4 copper conductor
 - Encased in at least 2 inches (50.8mm) of concrete
 - Reinforcing bar may be bonded together by the usual steel tie wires
 - NEC Reinforcing bar currents
 - Exterior bars carry more current

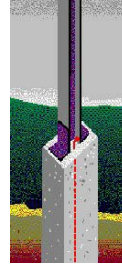

Safety Vs Performance

- NEC 250.52(A)(3) [2011] Concrete-encased Electrode
 - "An electrode encased by at least 50mm(2in) of concrete, located within and near the bottom of a concrete foundation or footing that is in direct contact with the earth...reinforcing bars shall be permitted to be bonded together by the usual steel tie wires or other effective means."
 - Construction practices often leave the steel reinforcing bars without grounding/bonding.
 - NEC Commentary: "If multiple concrete encased electrodes are present at a building or structure, it shall be permissible to bond only one into the grounding electrode system.
 - NEC Informational note: Concrete installed with insulation vapor barriers, films or similar items separating the concrete from the earth is not considered to be in "direct contact" with the earth





Reinforced Concrete Construction

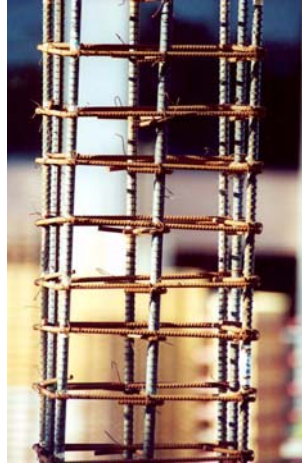

Steel Beam Construction





Ungrounded REBar

Frequency	Frequency	Ground Floor	Second Floor
AM Band	720 kHz	5.7 mV	0.143mV
	970 kHz	0.809mV	**
	1063 kHz	1.710mV	**
	1140 kHz	0.232mV	**
	1280 kHz	1.019mV	**
Low TV Band and FM Band	1463 kHz	0.292mV	**
	61 MHz	1.257mV	0.421mV
	66 MHz	0.361mV	0.246mV
	77 MHz	0.341mV	1.845mV
	82 MHz	0.246mV	0.455mV
	91 MHz	1.332mV	1.614mV
	94 MHz	1.384mV	1.037mV
High Band VHF TV	101 MHz	**	1.552mV
	181 MHz	1.742mV	0.276mV
	186 MHz	0.630mV	0.207mV
	193 MHz	1.019mV	0.667mV
	198 MHz	0.630mV	0.282mV
	206 MHz	0.618mV	0.152mV
	211 MHz	2.760mV	0.322mV
216 MHz	0.595mV	0.161mV	

** Signals too low to distinguish from signal noise floor

Table 1. Interference signals recorded on Ethernet Cables.

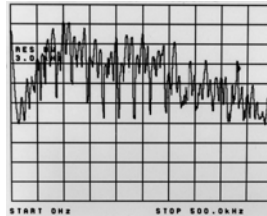
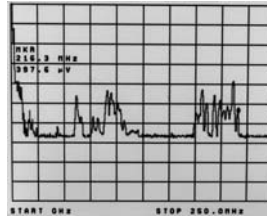

Ungrounded Metalwork

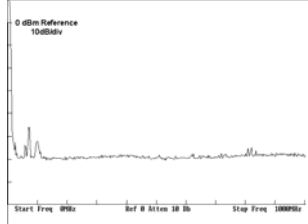
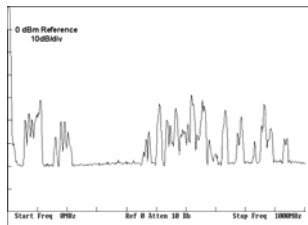



Electrically Conductive Concrete

- Conductive components
 - Carbonaceous particles & metallic compounds
- Uses
 - Deicing & snow melting of roadways & bridges
 - Ground plane effects in data centers & barns
 - Reducing electrolysis in grounding systems
 - Reducing earth resistance in grounding systems
 - Increasing surge current capabilities
 - Enhanced screen room control (Tempest)



San Earth Enhanced Concrete

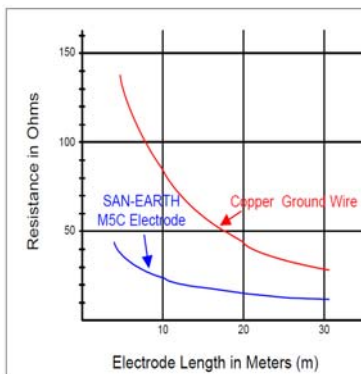

Electrode Depth: 0.5 meters
SAN-EARTH Electrode Width: 0.5 meters

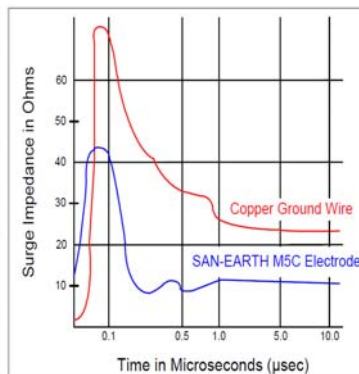

Surge Waveform: 1/100 µsec
Electrode Length: 40 meters
SAN-EARTH Electrode Width: 0.5 meters





Metal Cladding & Framework

- NEC 250.104(C) [2011]
 - Bonding of piping systems and exposed structural steel
 - Exposed metal building framework that is not intentional or inherently grounded and likely to be energized must be grounded per NEC 250.64.



Multiple Building Grounding 2005

- NEC 250.32 [2005] Common ac service
 - If no common grounding conductor extends between the buildings with multiple circuits then each building must have an established grounding electrode system with a separate neutral-to-ground bond in each building.
 - If a common grounded and grounding conductor extends between the buildings, and multiple circuits exist then a grounding terminal will be required in the connected buildings and no individual neutral-to-ground bonds will be permitted in each additional building.
 - If a single circuit extends to a second building and both grounded and grounding conductors extend to the second building then no ground terminal will be required and a neutral-to-ground bond cannot be established at the second building.



Multiple Building Grounding 1

- NEC 250.32 [2005] Common ac service
 - If a common grounded and grounding conductor extends between the buildings, and multiple circuits exist then a grounding terminal will be required in the connected buildings and no individual neutral-to-ground bonds will be permitted in each additional building.
- NEC 250.32(B)(1) (2011) Buildings or Structures supplied by a Feeder(s) or Branch Circuit(s).
 - An equipment grounding conductor, as described in 250.118, shall be run with the supply conductors and be connected to the building or structure disconnecting means and to the grounding electrodes(s)."
- Substantial neutral-ground voltages can develop that may adversely affect equipment in the second building.

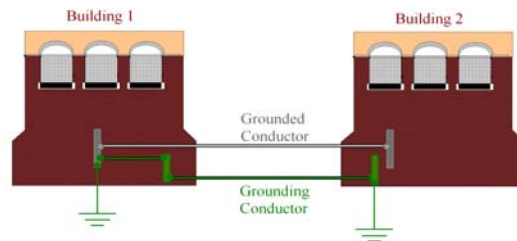

Multiple Building Grounding 2

- NEC 250.32 [2005] Common ac service
 - If no common grounding conductor extends between the buildings with multiple circuits then each building must have an established grounding electrode system with a separate neutral-to-ground bond in each building.
- NEC 250.32(B)(1) Exception [2011]
 - “For installations made in compliance with previous editions of this Code that permitted such connection, the grounded conductor run with the supply to the building or structure shall be permitted to serve as the ground-fault return path if all of the following requirements continue to be met.”

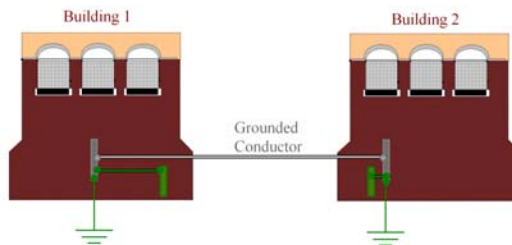



Multiple Building Grounding 3

- Regardless what grounding is implemented, data networks extending between the buildings are at risk.
- Shielded data cables grounded at each end can end up carrying return and fault currents.
- Lightning can easily destroy linked equipment.

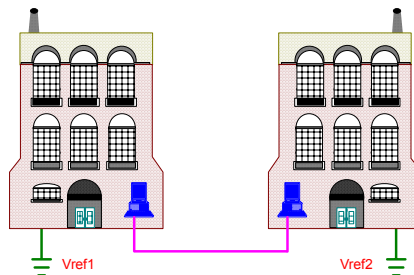

Lightning Protection Systems



Facility Grounding & Lightning

Lightning treatment

- Bond ground terminals to GES
 - NEC 250-106 [2011]
- Air terminal conductors and ground terminals are not to be used in lieu of intended GES
 - NEC 250.106 [2011]
- NFPA 780-2011 provides calculation for clearance from down conductors due to high voltage & ionization.
- Formerly, 250.106 FPN 2 in earlier Code specified 6' (1.83m) clear air spacing to conductive metalwork or 3' (0.92m) spacing through wood, concrete or brick)

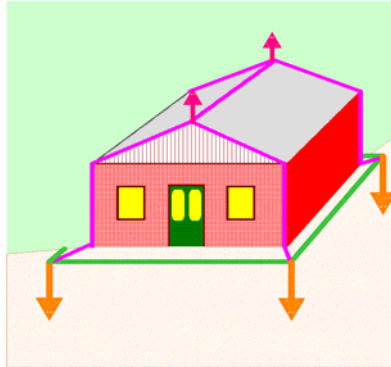

Effective Earth Terminals

Low impedance paths to earth

- Current density and path resistance determine voltage rise
- Low dc resistance does not guarantee effective current handling
- Surface radials may be most effective with sandy soil but well watered topsoil
- Lightning grounding systems bonded to electrical service and to facility structural steel





Lightning Transient Characteristics

- Return-stroke current
 - Unidirectional impulse (30 kA, 10 x 100 μ s)
 - Continuing currents (100 A, 10 mS)
- Non-connecting upward leaders
 - Bipolar impulse (100 A, 10 x 100 μ s)
- Induced currents
 - Unipolar & bipolar (10 A, 2 x 50 μ s)
- Self Inductance Vs Voltage Rise
 - 30kA return stroke with 10 meter conductor length
 - Conductor inductance; 1 μ H per meter
 - Voltage rise; $-V = Ldi/dt = 10E-06(30E03/10E-06) = 30,000V$
 - Single conductor discharge path does not work!!!



Electrical Services



Common Facility Power Systems

- Single phase
 - 240/120
- Three phase
 - 480/277 & 208/120

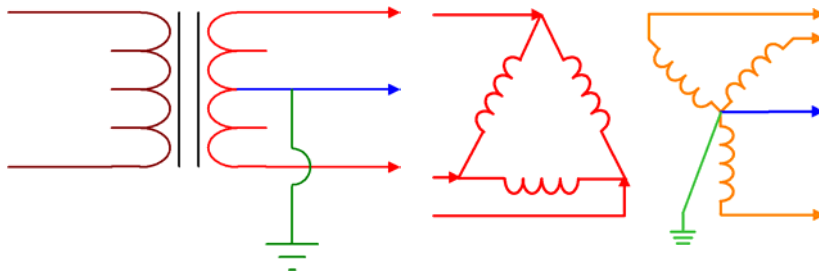

Common & Problematic Service

- Three phase delta voltages (240 delta)
- Single phase voltages (240/120)
- High leg delta (crazy leg, red leg etc.)

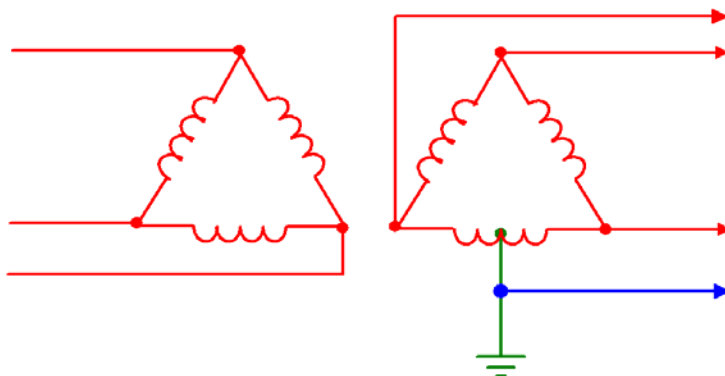



Power/Grounding Variations

- Floated wye
 - Ground referenced voltages vary with leakage currents
- Floated delta-delta
 - Ground referenced voltages vary with leakage currents
- Corner grounded delta
 - One leg at earth potential, others at phase-to-phase potential

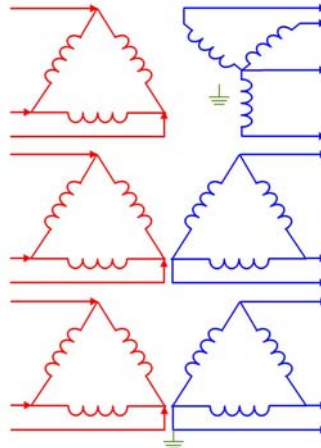

Floated Delta-Delta Service

- Absence of solid ground reference allows ground referenced voltage fluctuations
 - Load related fluctuations usually within voltage envelope of service
 - Utility related fluctuations reflect primary voltages
 - Lightning transients create severe dv/dt

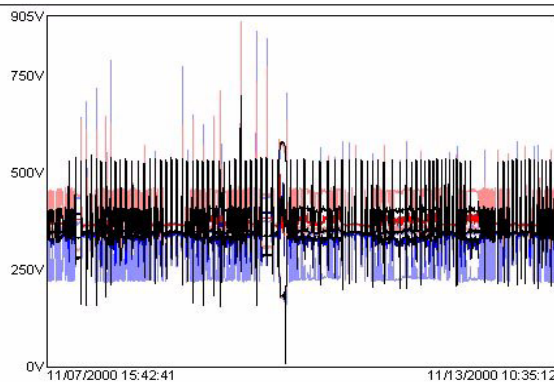



Impedance Grounded Source

- High-impedance grounded neutral systems
 - NEC 250-36 [2011]
 - Typically resistive but may be resonant or inductive
 - 480 to 1000Vac three phase systems with **No** line-to-neutral loads
 - Ground fault detection required
 - Impedance sized to prevent arcing faults
 - Neutral-to-ground bond sized for maximum current per the grounding impedance (ANSI/IEEE 142-1991 Green Book)
 - Equipment bonding jumper (from equipment grounding conductors to the grounding impedance) shall be sized per 250.66 or 250.36B.

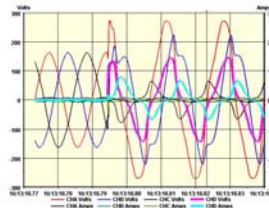
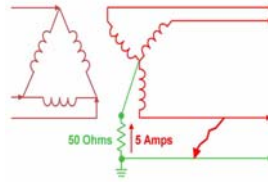

Wye-to-Wye Services

- Facility transformers
- Utility systems

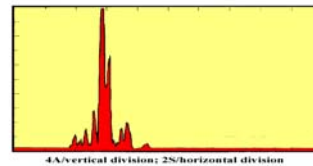
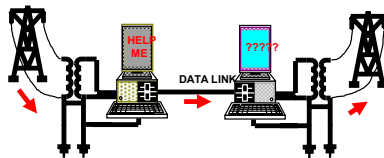
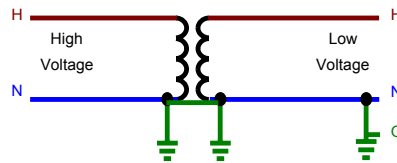



Transferred Earth Potential

▪ Transferred Earth Potential (TEP)

- IEEE Std 142-1991 (Green Book)
 - Sections 1.6.4; 1.6.7; & 4.2.6
- Wye-to-Wye & 240/120
 - Padmount applications prone to TEP

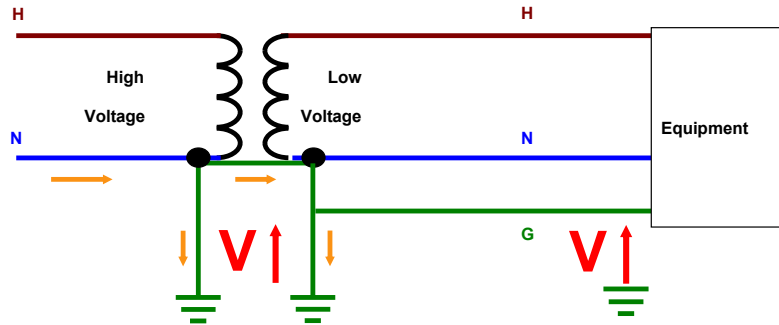

TEP Case History

Ground-to-Ground Voltage

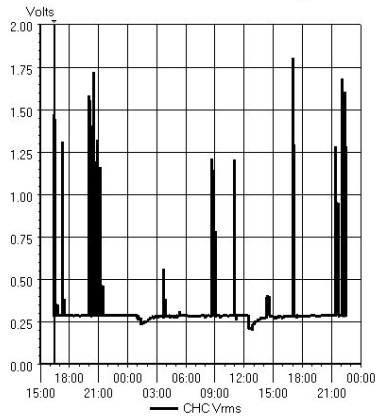

Equipment Ground Current

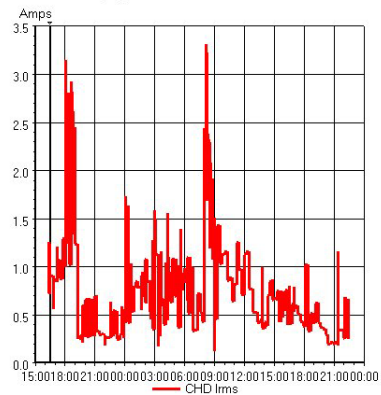



TEP; Lightning Two Miles Distant

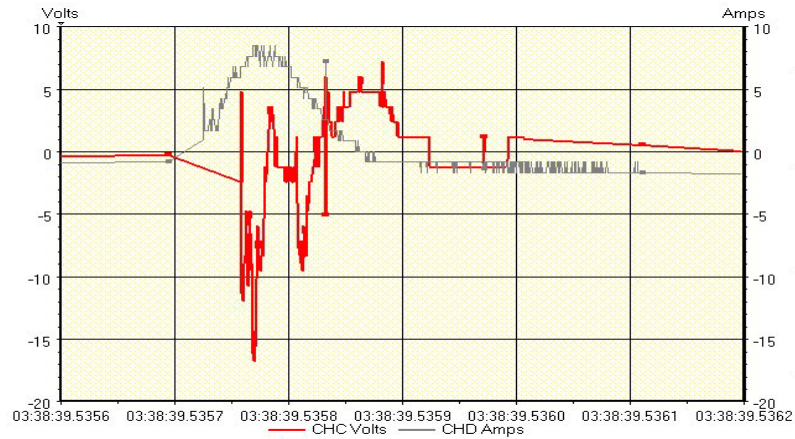

Distribution Grounding

- Feeders
- Transformers
- Separately derived sources
- Branch circuit wiring



Feeder Grounding

- Permanent, Continuous, & Contiguous
- Ampacity sufficient for fault currents
 - Conductors
 - Raceway
 - Conduit

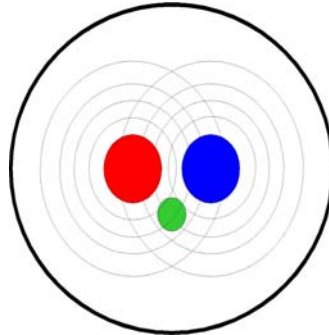

Grounding Conductor Sizing

- Article 250-122 [2011]
 - Wire size (AWG) tied to overcurrent protection (**A**)
 - If circuit length requires larger conductors, then grounding conductor size must also increase proportionally
 - In a parallel circuit each grounding conductor must be fully sized per the overcurrent protection for that parallel circuit
 - Table 250-122 conductor sizing

• 15A	= 14 cu or 12 al
• 20A	= 12 cu or 10 al
• 60A	= 10 cu or 8 al
• 100A	= 8 cu or 6 al
• 1000A	= 2/0 cu or 4/0 al

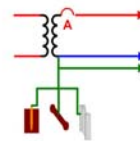



Parallel Feeders (1)

▪NEC

- NEC 310.10(H)(1) [2011]
- Symmetrical
- Prevent objectionable ground current
- Use same material for conductors
- Use same material for conduits/raceways
- Maintain same lengths
- Use proper conductor placement
- 1/0 and larger
- Grounding conductor sizing
 - NEC 250-122 [2011]



Parallel Feeders (2)

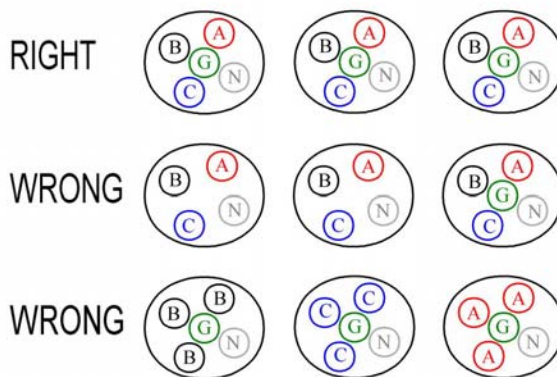



Separately Derived Sources

- Neutral continuity is the key determinant. If the neutral is interrupted or switched then the source is probably separately derived.
- If separately derived then the source must be bonded to the building grounding electrode system (GES).
- Autotransformers (voltage changers) are not separately derived.

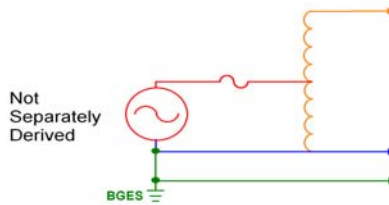
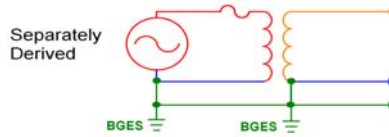

Separately Derived Sources

- NEC 250-30 [2011]
 - Major re-write in 2011
 - Transformers, UPS equipment, Motor generators
- Figure status
 - A = Not Separate -- Neutral is continuous
 - B = Separately derived -- Neutral not continuous
- Bonding
 - NEC 250.30(A)(4) [2011]
 - Water pipes or steel, but water pipes not preferred unless metal pipes are continuous and maintained
 - Bonding to water pipes in areas served
 - NEC 250.104(A)(1) [2011]

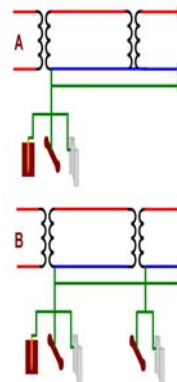



Fault Clearing

Primary Fault

Secondary Fault

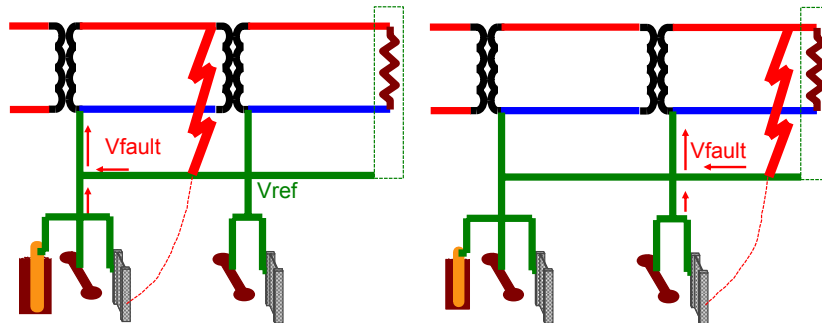

Common Grounding Electrode

- In facilities lacking structural steel or continuous, metal water piping, a common grounding electrode may be used for separately derived equipment.
 - NEC 250.30(A)(6)(a) [2011]
- Conductor sizing
 - Minimum size per is 3/0 AWG copper or 250 kcmil aluminum.

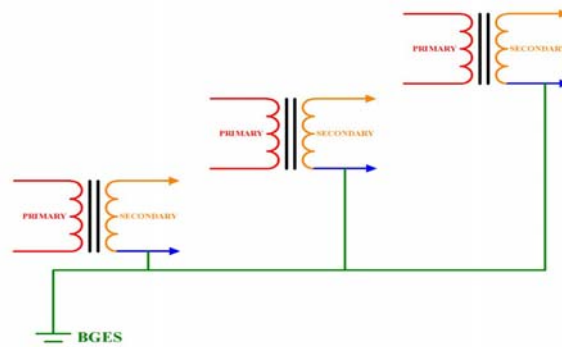



Continual Neutral Generator Setup

- Not separately derived
- 3 Pole ATS
 - Automatic transfer switch
- GES
 - Grounding electrode system

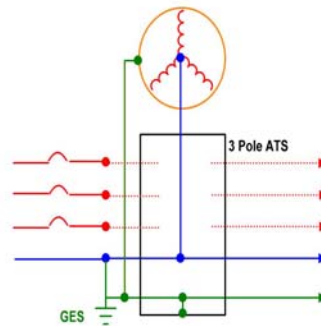

Switched Neutral Generator Setup

- Separately derived
- 4 Pole ATS
 - Automatic transfer switch
- GES
 - Grounding electrode system

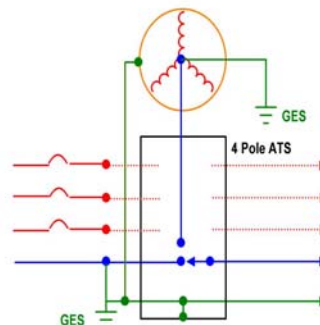



Ground Fault Detection



Ground Fault Circuit Interrupt

- Protection for personnel: NEC 210.8 [2011]

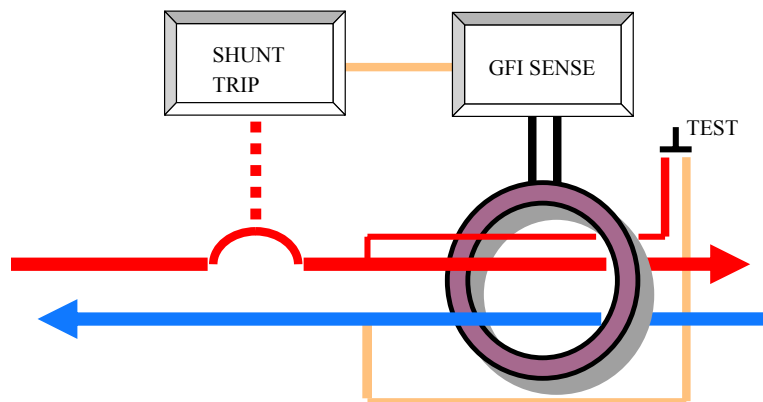



Facility Ground Fault Protection

- **Service entrance**
 - Protection for switchgear
 - NEC 230-95 [2011]
 - >1000 ampere
 - >150V L-G but not exceeding 600V Phase-to-phase
 - Maximum response levels: 1200 amperes & 1 second
 - Slowest and highest response levels at service entrance
- **Exceptions**
 - Service entrances with multiple input breakers (six or less) with ampacities equal to or less than 800 amperes.
 - Continuous industrial services where the interruption of power poses more hazard than relying upon normal overcurrent interruption
 - Services with high impedance grounded neutral systems.
- **Emergency services**
 - Interrupt not required; NEC 700.26 [2011]
 - Ground fault detection required - NEC 700.6(D) [2011]



Ground Fault Interrupt 1

- Polyphase -- single CT GFI -- "zero sequence"

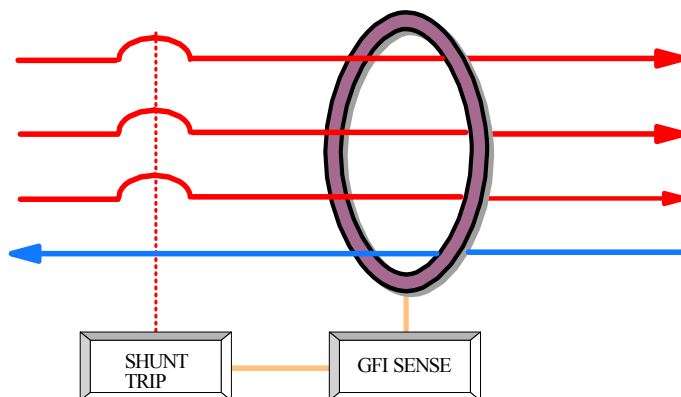



Ground Fault Interrupt 2

- Polyphase -- Multiple CT GFI -- "residual"

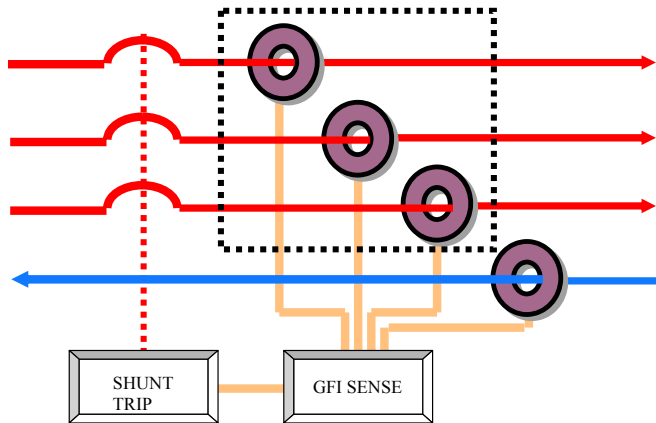

Ground Fault Interrupt 3

- Neutral-to-ground bond detect - "source"

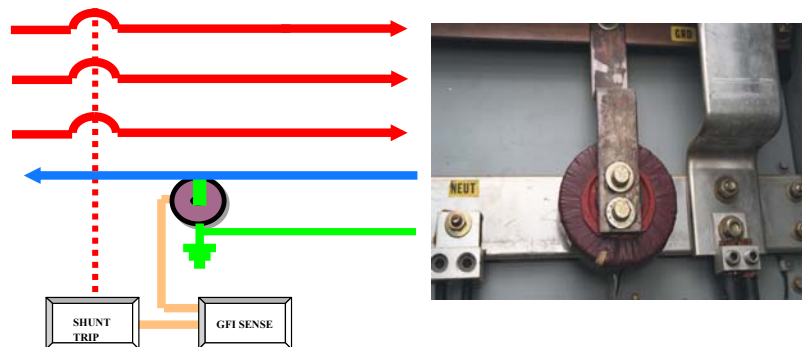



GFI Problems

- Magnetic pickup from adjacent circuits
- Voltage and current harmonics vs CT response
- EMI/RFI sensitivity
- Trips settings too low for the application
- GFI on primary of N/G bond in wye-to-wye systems
- Neutral return current flow through N/G bond CT in multiple grounding systems



Equipment Grounding



Equipment Grounding

- 250 VI & VII [2011]
 - Effectively grounded
 - NEC 250.4(A)(3) [2011]
 - Continuous & Contiguous - Capacity to safely conduct fault current
 - Limit voltage to ground (touch potential) - Ensure rapid fault clearing
 - NEC 250.4(A)(5) [2011] Effective Ground-Fault Current Path
 - "Electrical equipment and wiring and other electrically conductive material likely to become energized shall be installed in a manner that creates a permanent, low-impedance circuit facilitating the operation of the overcurrent device or ground detector for high-impedance grounded systems. It shall be capable of safely carrying the maximum ground-fault current likely to be imposed on it from any point on the wiring system where a ground fault may occur to the electrical supply source. The earth shall not be considered as an effective ground-fault current path."



Equipment Performance Issues

- Complications
 - Equipment reference
 - Leakage current
 - DC common & ac ground
 - Induced chassis potentials

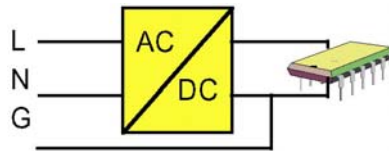



Grounding Discontinuity

Neutral/Ground Voltage

- Leakage current
- Grounding discontinuity
- Chassis voltage
- Data loss
- Equipment reset

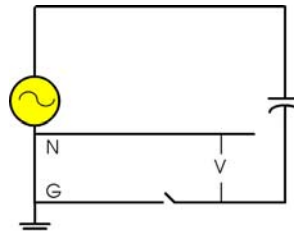
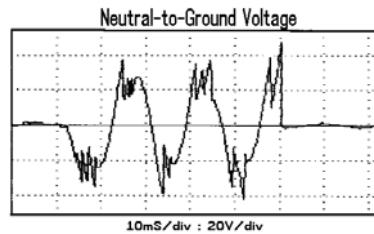

Connection Quality

- Connections become loose with age
- Screw connections
 - Too loose -- bad
 - Too tight -- bad
 - Proper torque -- rare
- Grounding wire essential





Equipment Emissions

- High frequency emissions
 - Pulse width modulation
 - Power factor correction
 - Clock/logic circuits
 - I/O circuits
 - Intentional RF use
- FCC limits
 - Class A (commercial)
 - Class B (residential)
 - 9kHz and higher
 - 450kHz is the lower measurement level
 - 127dBuV = 2.24Vrms

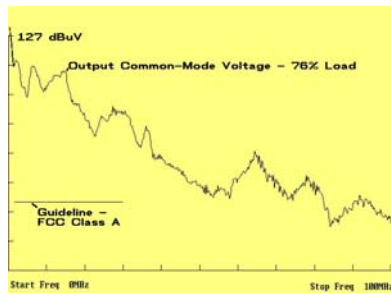

High Frequency Leakage Current

- Kirchoff's Laws prevail
 - Pulse width modulation (PWM) Noise
 - Power factor correction (PFC) Noise
- Skin effect & inductance dominate
- Ground is a path, not the terminus

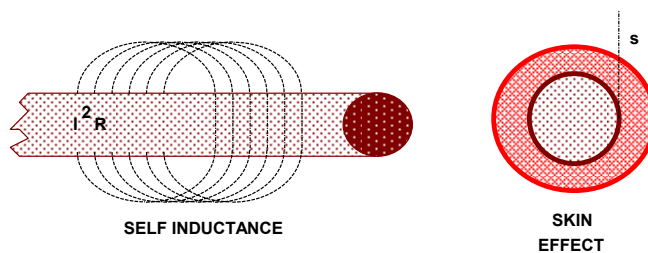



Flexible Wiring Systems

- Intended use
 - Limited length, voltage and ampacity
 - Usual use - lighting circuits
- Types
 - FMC - Flexible metallic conduit
 - FMT - Flexible metallic tubing
 - Metal Clad (MC)
- Grounding
 - NEC 250.118(5) [2011]
 - 6 feet length (1.83m)
 - Less than 20 amperes

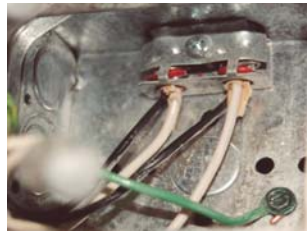

Equipment Leakage Current

- UL limits
 - 3.5mA power frequencies
 - Formerly 0.5 mA to 5mA
 - Portable, cord connected devices
- Circuit Testers
 - 2mA maximum
 - Read & follow instructions!
 - Disconnect loads before use
- Sources
 - Capacitive coupling
 - Wiring errors
 - I/O circuits

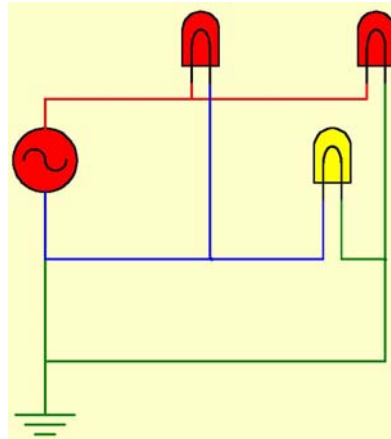



Receptacle Orientation

- NEC
 - No specified position
- IEEE White Book
 - IEEE Std. 602-1996
 - Section 4.2.2
 - "Ground pin or neutral blade up"
 - Reduces accidental contact with exposed live contacts.



Randomly Placed Raceway Wiring

- NEC 300.20 Induced currents in metal enclosures or metal raceways [2011]
 - "Where conductors carrying alternating current are installed in ferrous metal enclosures or ferrous metal raceways, they shall be arranged so as to avoid heating the surrounding ferrous metal by induction. To accomplish this, all phase conductors and, where used, the grounded conductor and all equipment grounding conductors shall be grouped together."
- PQ Implications: Grouping the wires will reduce coupling to adjacent circuits!





Conductor Types

Cable 1 = NEC/MC
 3 phase, 3 grounds, no shield, aluminum interlocked

Cable 2 = NEC/TC
 3 phase, 3 grounds, no shield, no armor, tray cable

Cable 3 = NEC/MC
 3 phase, 3 grounds, no shield, galvanized interlocked steel

Cable 4 = NEC/MC
 3 phase, 1 ground, no shield, aluminum continuous

Cable 5 = NEC/MC
 3 phase, 3 ground, copper tape spiral shield, galvanized steel interlocked

Cable 6 = IEC/MCMK
 3 phase sectored symmetrical, no grounds, copper tape & wire shield, no armor

Cable 7 = IEC/MCMK
 IEC 3 phase sectored symmetrical, 1 ground, copper tape & wire shield, no armor

Cable 8 = NEC/MC
 3 phase, 3 grounds, no shield, aluminum continuous

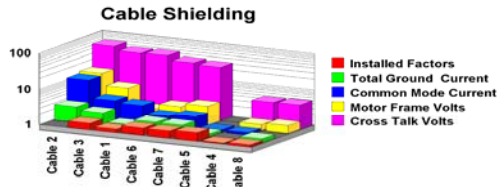

Source: March/April IEEE Transactions on Industry Applications
 Evaluation of Motor Power Cables for PWM AC Drives
 John M. Bentley & Patrick J. Link



Symmetrical Cable Variations

- Equal inductive coupling
 - Magnetic field
- Equal capacitive coupling
 - Electric field
- Shielding controls common mode emissions
- 400Hz applications require symmetrical cabling

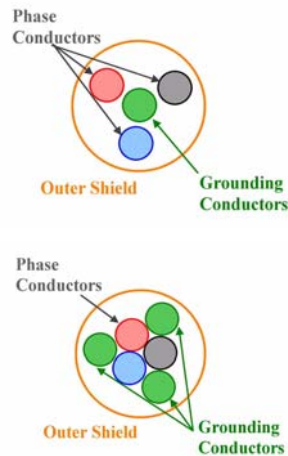



Parity Ground Conductor Sizing

- Parity sizing
 - Grounding conductor the same size as current carrying conductors
 - Not a code requirement
 - Normally a vendor requirement
 - Attempt to improve equipment reference
 - Larger conductor size
 - May magnetically or capacitively couple
 - Use may increase ground current

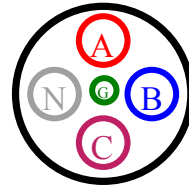
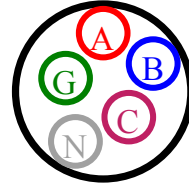

Parity Sizing Problem

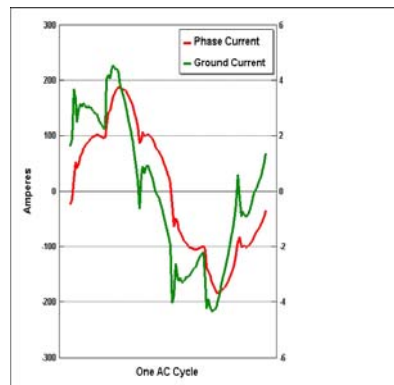
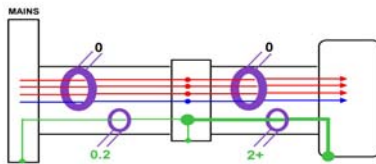



Reference Grounding

Computer rooms
Raised floor environments
Data processing centers



A Tale of Two Towers

- 500MCM conductors added to "improve reference"
- Added grounding adversely affected equipment

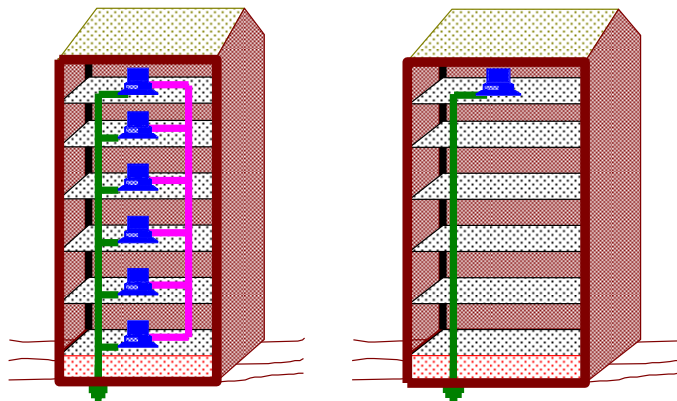



Interference Signals in Equipment Wiring

- Federal Information Processing Standards Publication
 - FIPS PUB 94 -- 1983 September 21 -- Now discontinued
 - US Department of Commerce - National Bureau of Standards
- Guideline on Electrical Power for ADP Installations

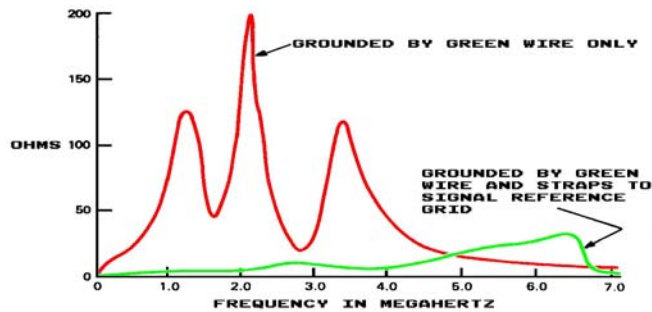

Ground Voltage Rise (200' Romex)

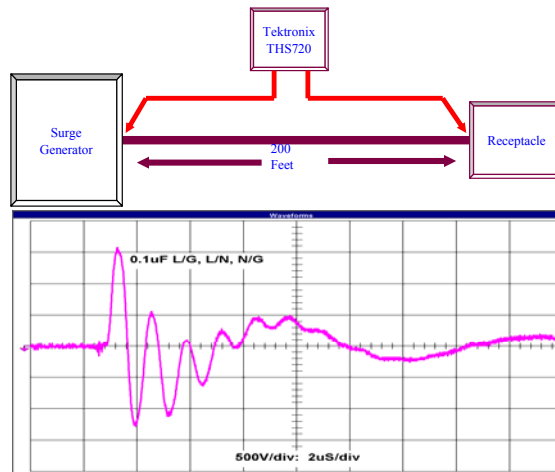



Ground Voltage Differentials

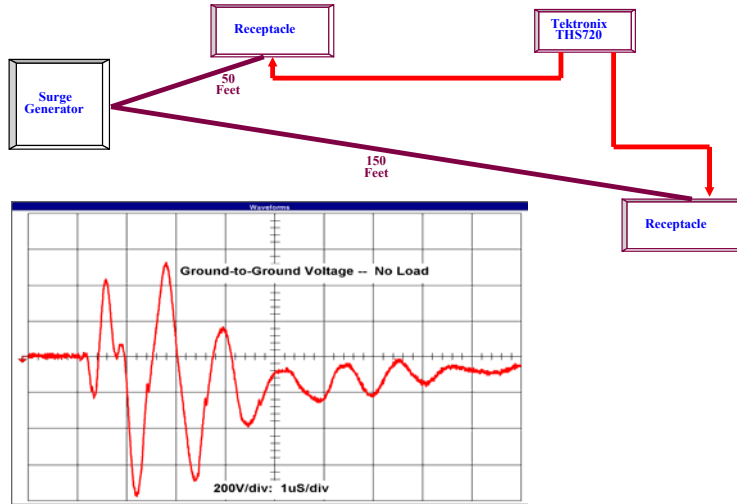

Signal Reference Grid (SRG)

- FIPS PUB 94
 - 4 AWG copper conductors -- clamped intersections
 - Not a bad reference grid
 - 1" metal braid and pedestal clamps
 - A better reference grid

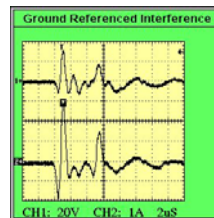
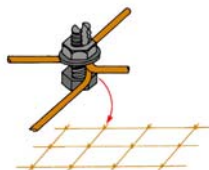
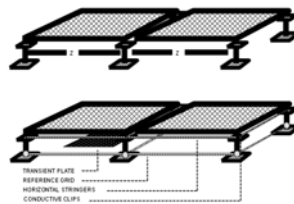



4'x4' Reference Grid

- SRG intersection points not bonded together
- Less effective than would be with good connections.



Connections to Reference Grid

- Short flat straps best
- Metal braid OK
- Bond at opposite corners of equipment
- Bond all equipment within room





Signal Reference Grid

- A very good reference grid

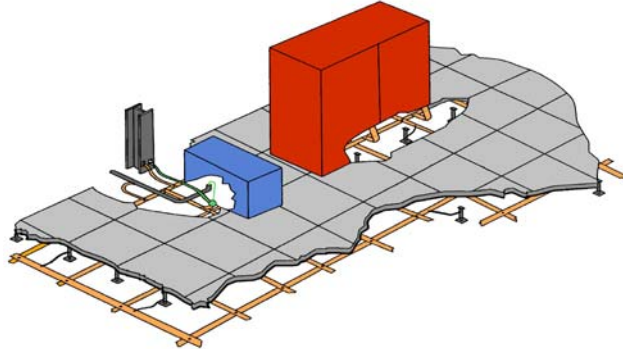

Information Technology Rooms

- Article 645 of NEC
 - NEC 645.15 Grounding [2011]
 - Power systems that supply power through receptacles or cable assemblies supplied as part of the system are not considered as separately derived.
 - Signal reference systems must be bonded to the equipment grounding system provided for the information technology room.
- Recommended References
 - NFPA 75-1995
 - *Standard for the Protection of Electronic Computer/Data Processing Equipment*
 - IEEE Std. 1100-1992 -- Emerald Book
 - *IEEE Recommended Practice for Powering and Grounding Sensitive Electronic Equipment*



Communications Grounding



Point of Entrance (POE) Grounding

- Article 800 [2011]
 - Communications Circuits
- Article 810 [2011]
 - Radio & TV Equipment
- Article 820 [2011]
 - Community Antenna Television and Radio Distribution System
- Article 830 [2011]
 - Network Powered Broadband Communications Systems



Communications Grounding 2002-2005

- NEC recommendation
 - Sheath grounding at point of entrance NEC 800-33 [1996, 1999, 2002]
 - The metallic sheath of communications cables entering buildings shall be grounded as close as practicable to the point of entrance or shall be interrupted as close to the point of entrance by an insulating joint or equivalent device.
 - This entire reference was removed in 2011 Code.
 - NEC 800.2 Definitions [2011]
 - Within a building, the point at which the wire or cable emerges from an external wall, from a concrete floor slab, or from a rigid metal conduit or an intermediate metal conduit grounded to an electrode in accordance with NEC 800.100(B) [2011].



Cable Sheath Grounding - 2005

- NEC 800.40(B)[2002] & 800.100(B)[2005]
 - 1 Building or structure grounding electrode system
 - 2 Grounded interior metal water piping system within 5 ft. from its point of entry into the building [per 250.52 [2005]
 - 3 The power service accessible means external to enclosures as covered in 250.94
 - 4 The metallic power service raceway
 - 5 The service equipment enclosure
 - 6 The grounding electrode conductor or the grounding electrode conductor metal enclosure
 - 7 The grounding conductor or the grounding electrode of a building or structure disconnecting means that is grounded to an electrode as covered in 250.32.



Communications Grounding 2008

- Sheath grounding at point of entrance NEC 800.93(A)
 - The metallic sheath of communications cables entering buildings shall be grounded per 800.100 as close as practicable to the point of entrance or shall be interrupted as close to the point of entrance by an insulating joint or equivalent device.
- Grounding Methods 800.100 & 820.110
 - Grounding conductor shall be listed and insulated.
 - Grounding conductor shall be copper or other corrosion resistant material – stranded or solid.
 - Grounding conductor shall not be smaller than 14AWG and should be sized to match the current carrying capacity of the shield. It need not be larger than 6AWG.
 - The conductor shall not be longer than 6.0m (20 ft). If longer then a separate driven ground rod shall be installed and a bonding jumper should be installed to the building grounding means.
 - The conductor shall be run in a straight line as practicable.
 - If intersystem grounding exists between buildings then the grounding should connect to the intersystem grounding.



Telecom Entrance

- Telecom Grounding
 - Bond to GES
 - Sheath
 - Protectors
 - Never bond to the SRG!!!
 - Bond at point of entry
 - Penetration through wall or floor
 - Code Exception
 - Bond at point where cable emerges from rigid conduit
 - This practice brings unwanted interference into building

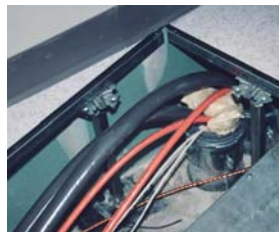
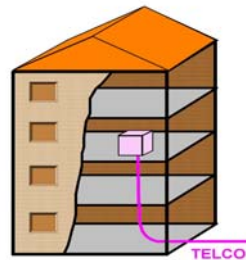



Ground Windows

- Theory
 - All grounding contacts single point
 - Create equipotential grounding
- Reality
 - DC concept
 - Path for circulating currents
 - Small scale application

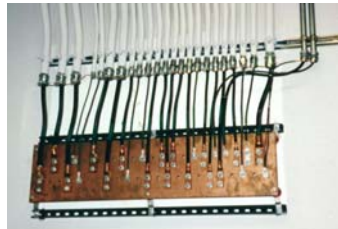

Telecom Demarcation

- Demarcation is not always the point of entrance
 - Typical - Point where cable emerges from rigid conduit
- Demarcation
 - Point of transfer from Telecom supplier to facility
- Over-voltage-protectors (OVP)
 - Gas tube
 - Carbon block





Protector & Sheath Grounding

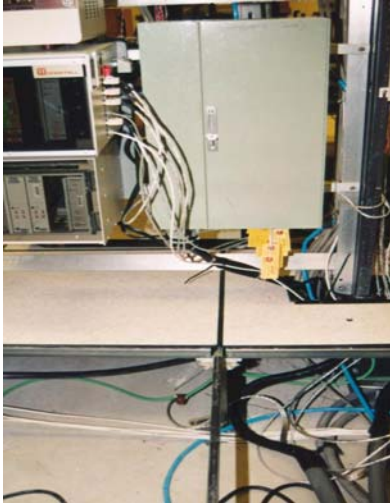

Telco Protector Grounding 1

▪Will Not Work -- BAD!!!!

▪Common -- May Not Work

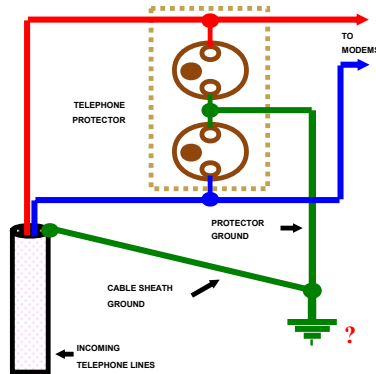
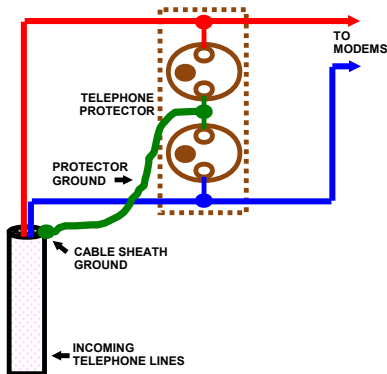



Telco Protector Grounding

- Better -- Might Even Work!
- Separate grounding paths
 - Sheath & protectors
 - Grounding point part of building grounding electrode system
- Placement is critical
 - Too close to load and secondary protectors will fire rather than intended primary protectors

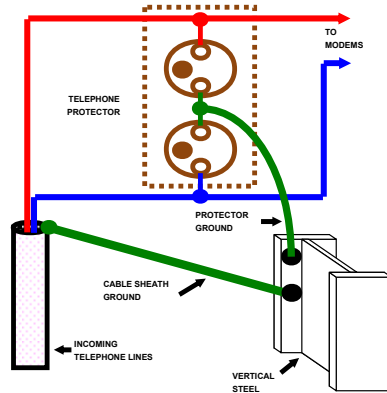

Coupling to Communications

- Common trench
 - Bell recommendations
 - 1 foot separation minimum
 - Bonding every 1K feet
- TIF
 - Telephone Influence Factor
 - Harmonic content affects data and voice signals

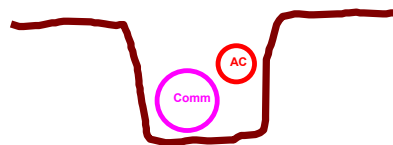
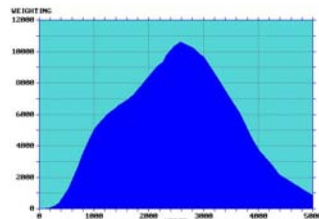



Telco Sheath Current

- Sheath Grounded
 - 2.8 Amperes RMS
- Sheath Not Grounded
 - 15 Volts RMS
- Interference worse without sheath grounding

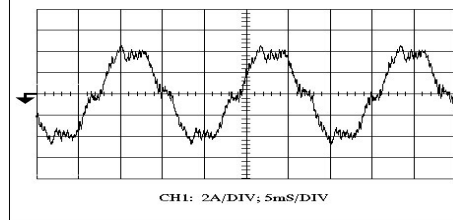
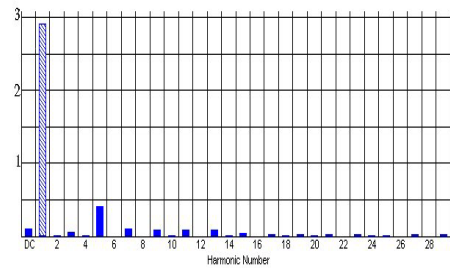

Shield Grounding Dilemma

- Grounding concerns
 - Ground one end or both ends?
 - Ground loops
 - Emissions?
 - Data integrity?
- Grounding Realities
 - Floated at one end causes potential
 - Grounded at both ends causes current

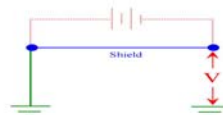
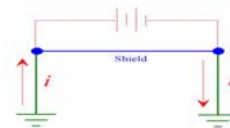



Shield Grounding Surge Test

- 8 x 20 uS Pulse
 - 1000Vpk
 - 500Apk
- 100kHz Ringwave
 - 6000Vpk
 - 500Apk

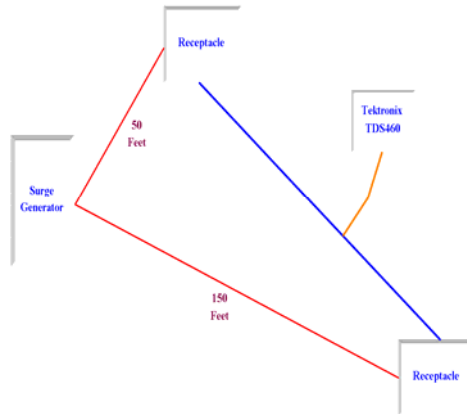

Test Pulse

Coax Current = 42Apk

Center pin voltage = 4.88Vpk

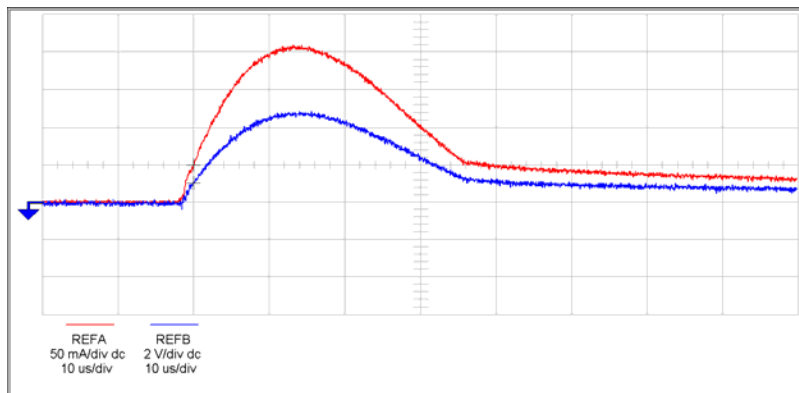



Open Shield

Coax Current = 4.4Apk

Center pin voltage = 180Vpk

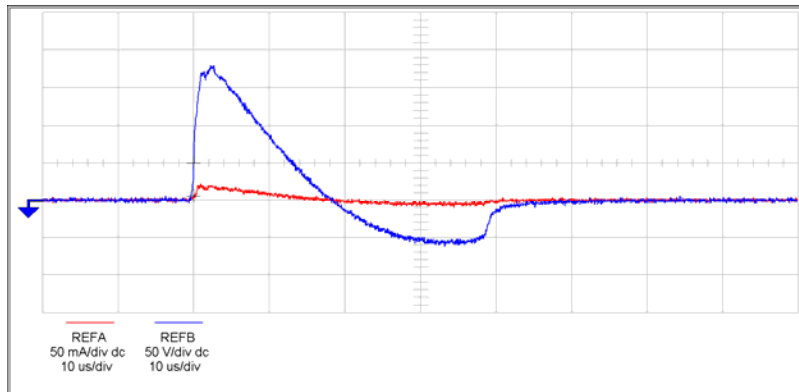

2" Drain Wire (Pig Tail)

- 8 x 20 uS Unipolar
- Coax Current = 41.6Apk
- Center pin voltage = 16Vpk

- 100kHz Ringwave
- Coax Current = 35.2Apk
- Center pin voltage = 72Vpk

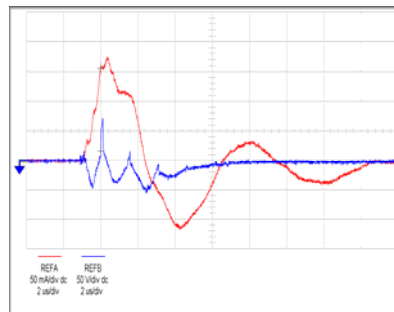
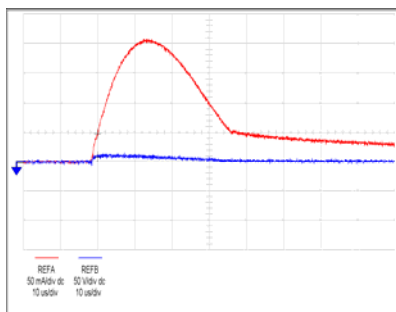



MOV

Coax Current = 27.2Apk

Center pin voltage = 58Vpk

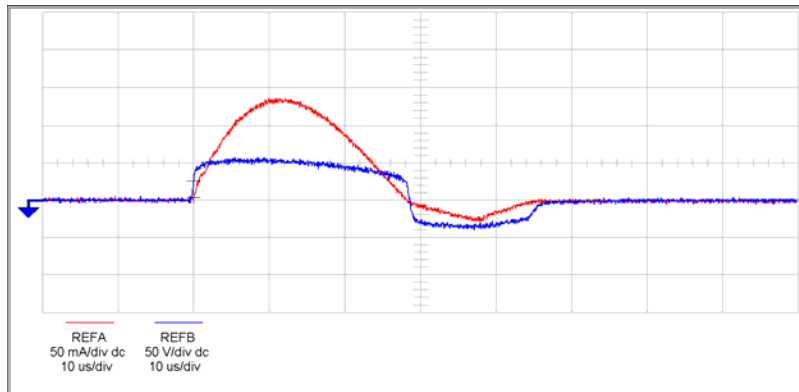

Shield Grounding Concerns

- Shields are intended to carry current
 - Current must flow to chassis without interruption
- Floated shields
 - May flash over
 - May leak high frequencies into "protected" circuits
- FCC testing
 - Usually performed with shields grounded at each end
- Data circuit may be grounded at both ends
 - RS-232 & RS-423



Grounding Complications

Sensitive Equipment
Isolated grounding
Supplemental grounds



Sensitive Electronic Equipment

- NEC 647 [2011]
 - Originally intended for audio studios --
now Industrial/commercial applications
- Requirements
 - Separately derived system
 - 2 pole breakers
 - 2.5% & 1.5% feeder/branch circuit
voltage drop
 - All 15 & 20 amps circuits must be
GFCI protected
 - Ground bus label -- Technical Power
 - IG receptacles allowed
 - Three phase applications require the use
of 6 phase transformers

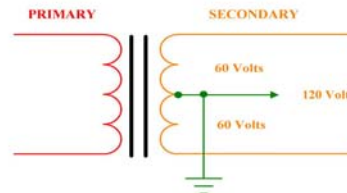



Isolated Grounding (IG)

- Isolated grounding receptacles
 - NEC 250-146(D) [2011]
- Isolated grounding passing through panelboards
 - NEC 408.40 Exception [2011]
- Grounding must terminate within the derived service



IG vs Regular Receptacle

▪ IG Receptacle

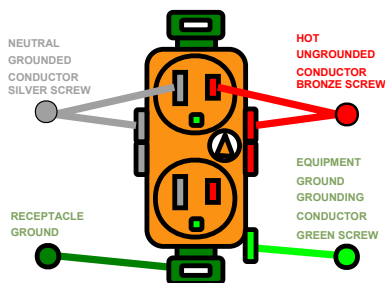

▪ Regular Receptacle

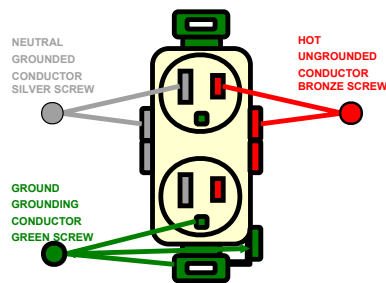



IG Application

- IG Normal application
 - IG passes back through panels to service origin.
 - Grounding wire size must increase to match ampacity of panels it passes through.
- Derived service
 - IG must terminate at the derived service.
 - Stepdown transformer is the derived service, not the main electrical entrance.

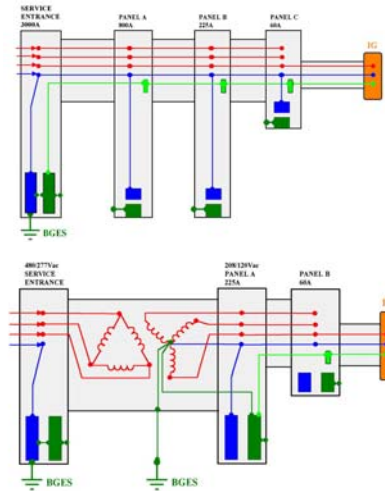

IG Position – Reality Check

- Normal distribution wiring spreads incoming signals across many circuits.
- IG circuit extending back to service entrance assures larger signals at "protected" load.

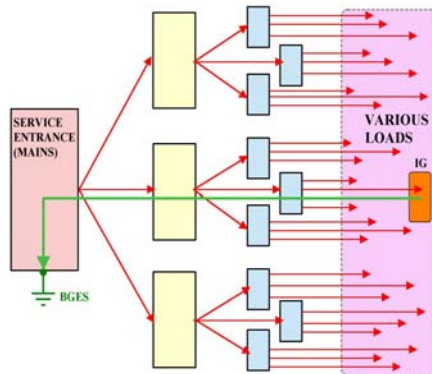



IG Circuit Coupling

- $-V = L(di/dt)$ -- mutual inductance
- Functions as a 1:1 transformer
- IG use may contribute to "ground loops"

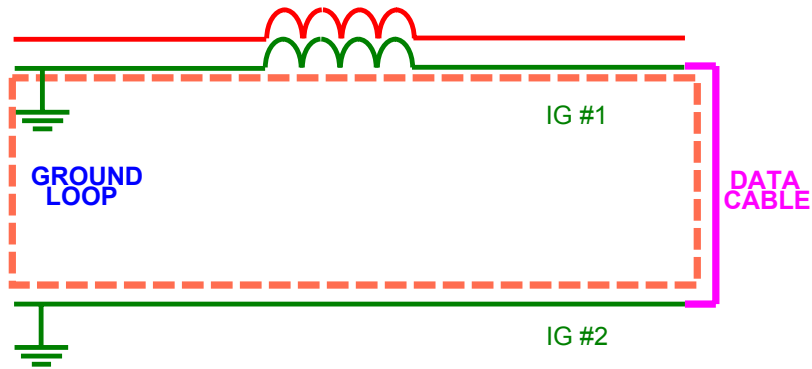

IG Circuit Induced Voltage

- Chassis voltage and data cable current
- Phase current & induced chassis voltage

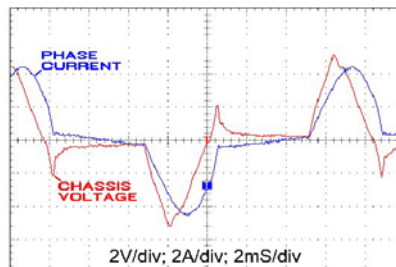
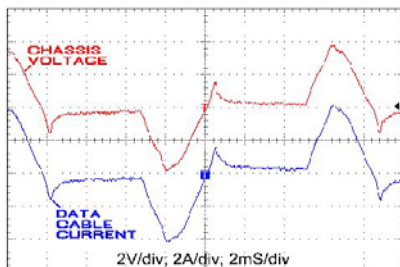



IG Ground Referenced Oscillation

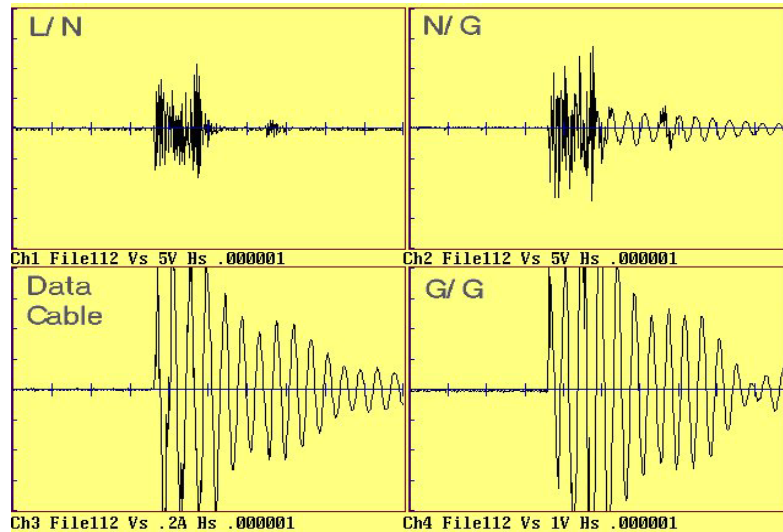

Common IG Errors

- Top figure
 - IG run separately from current carrying conductors
 - IG does not terminate at the derived service
- Bottom figure
 - IG grounding is separate from facility grounding.
 - Supplemental grounding at IG cannot serve as the sole grounding

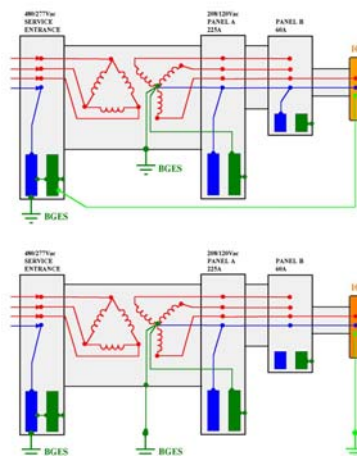



Isolated Ground Path Problem

- Common mode voltage propagation - Source is equipment leakage current due to an overloaded EMI/RFI power supply filter.
- Effects include lockup, reset & blown serial ports.

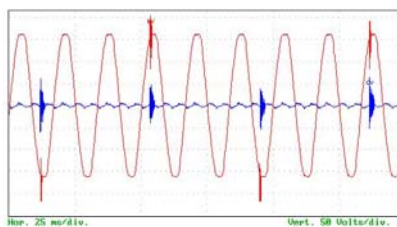
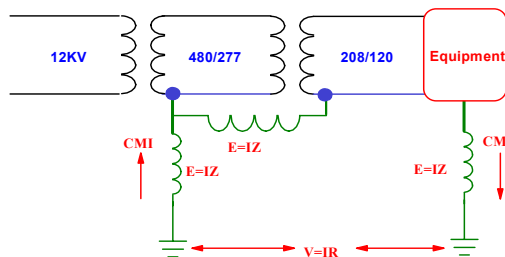

Isolated Grounding Effects

- Destructive Common mode voltage
- Voltages develop across I/O circuits

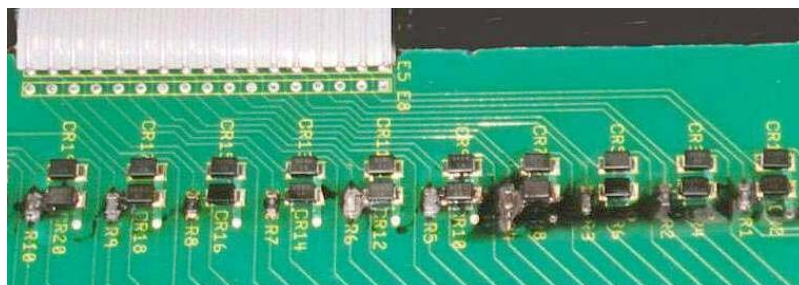



Auxiliary (Supplementary) Grounding

- Use is permitted
 - NEC 250.54 [2011]
 - Earth is not an effective grounding means and cannot be the sole grounding means as specified in 250.4(A)(5) [2011] and 250.4(B)(4) [2011]
 - Supplemental grounding need not meet the electrode grounding provisions of NEC 250.50 or 250.53(C) [2011]



Auxiliary Grounding

- Supplemental grounding provides a path for external ground referenced interference to enter a facility
- Avoid use if at all possible

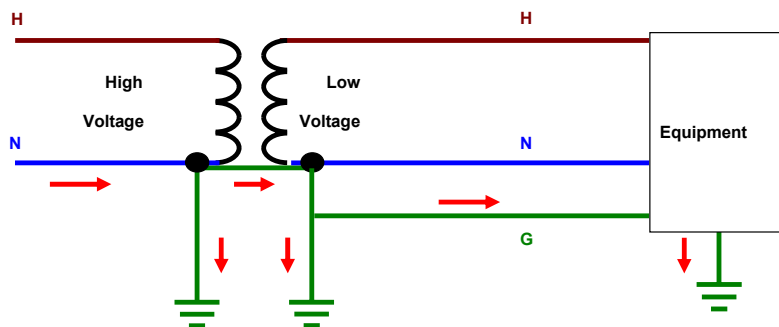



Supplementary Grounding Solutions

- Re-derive & Re-reference

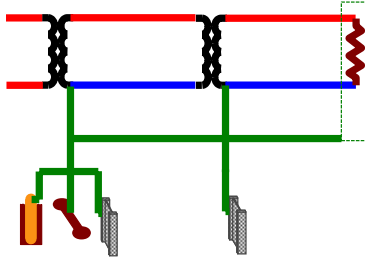

- Bond to facility reference

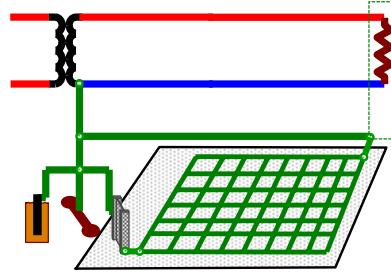

DC Grounding



DC Grounding Connections

- NEC 250.162(A) [2011]
 - Two wire, direct-current systems
 - Operating voltage greater than 50V but less than 300V shall be grounded
- NEC 250.162(B) [2011]
 - Three wire, direct-current systems
 - The neutral shall be grounded
- NEC 250.164 [2011]
 - Point of connection for direct-current systems
 - Grounding must occur at the first system disconnecting means and not at individual services or at any point of use in the premises wiring
- NEC 250.166 [2011]
 - Size of Direct-Current Grounding Electrode
- NEC 250.169 [2011]
 - Ungrounded Direct-Current Separately Derived Systems



Isolated Vs Contiguous Grounding

- A = Isolated grounding
 - DC return grounded independently
 - Voltage differential possible between AC power and dc system
- B = Contiguous grounding
 - DC bonded to ac grounding means
 - DC grounding run with ac conductors

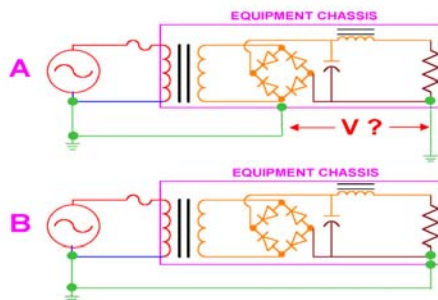



Separate DC Grounding Conductor

- DC grounding tied to main facility grounding
- DC grounding conductor run independent of ac conductors
- Attempt to prevent cross-talk between ac and dc conductors

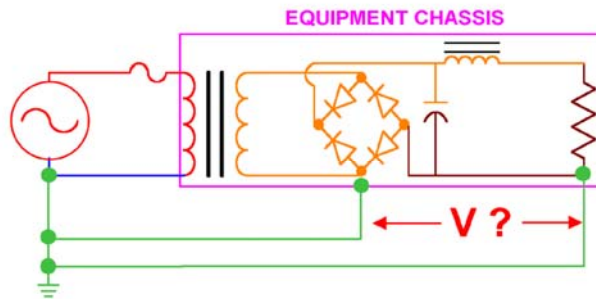

Multiple DC Reference

- Extra dc reference points turns grounding into a dc path
- DC current flows everywhere (inversely proportional to the dc resistance values).

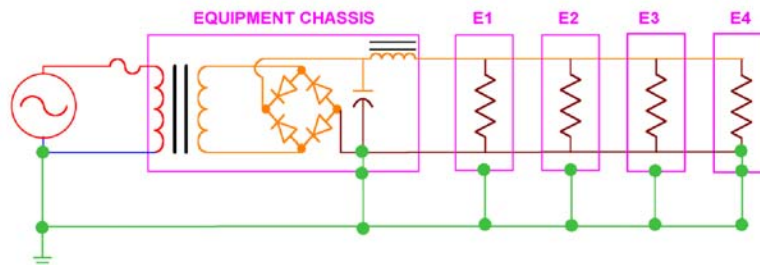



DC Systems and SRG

- Provides an installation consistent with the IEEE Emerald Book

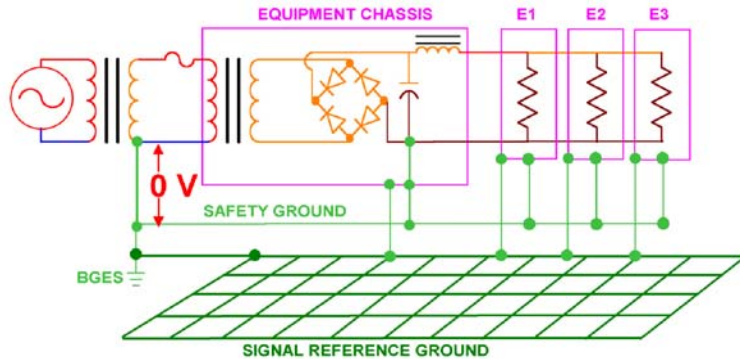

DC Bus Grounding

- A = Isolated grounding
 - DC return grounded independently
 - Voltage differential possible between AC power and dc system
- B = Contiguous grounding
 - DC bonded to ac grounding means
 - DC grounding run with ac conductors

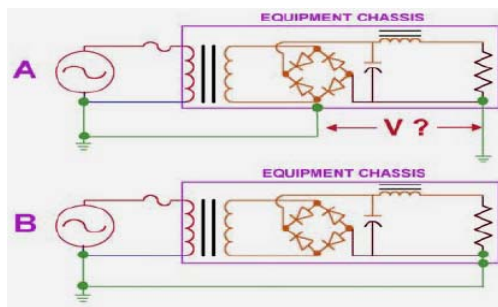



Separate DC Grounding Conductor

- DC grounding tied to main facility grounding
- DC grounding conductor run independent of ac conductors
- Attempt to prevent cross-talk between ac and dc conductors

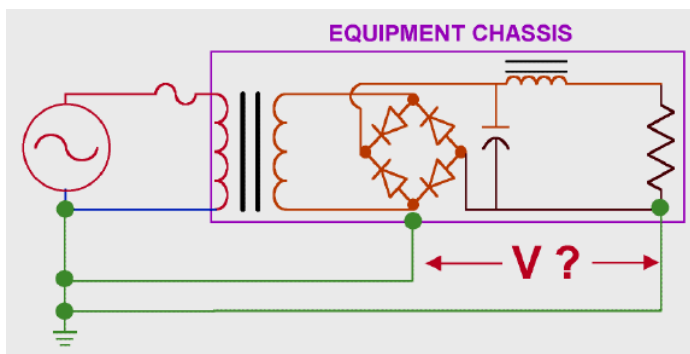

Multiple DC Reference

- Extra dc reference points turns grounding into a dc path
- DC current flows everywhere (inversely proportional to the dc resistance values).

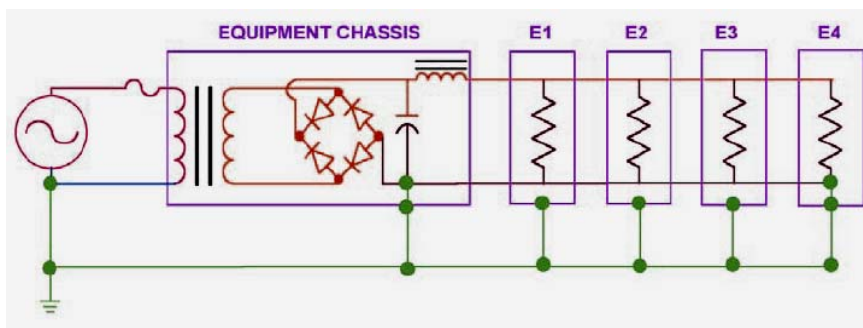



Bonding Dual Power Sources

- Dual power sources used to ensure redundancy.
- Dual sources can be affected by “ground skew.” Ground skew refers to voltage differences between sources.
- Bonding the sources together as well as bonding to the BGES helps reduce ground loop currents through equipment powered from the dual sources.

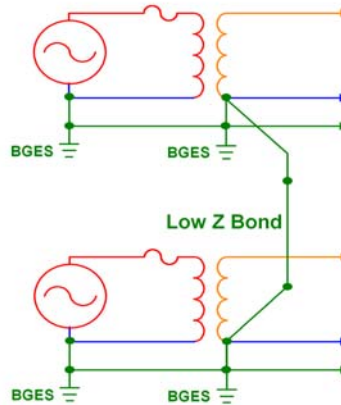

AC & DC Sources

- AC & DC sources must also be bonded to the BGES to reduce common mode potentials in equipment powered from the sources.
- Supplemental DC return bonds to ground cannot be placed at equipment. This causes unwanted DC current flow throughout the facility.

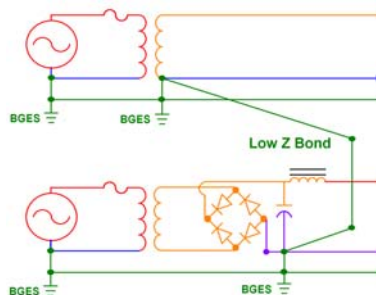



DC Bus Grounding

- A = Isolated grounding
 - DC return grounded independently
 - Voltage differential possible between AC power and dc system
- B = Contiguous grounding
 - DC bonded to ac grounding means

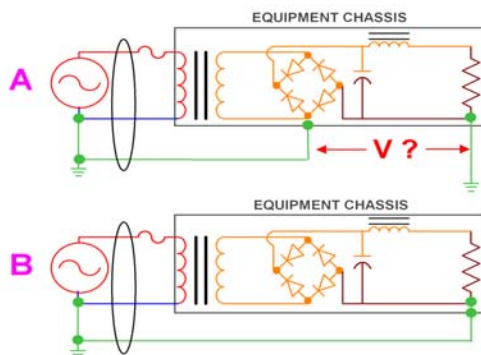

Common Mode Problems

- AC reference?
- DC reference?
- Potential between systems?

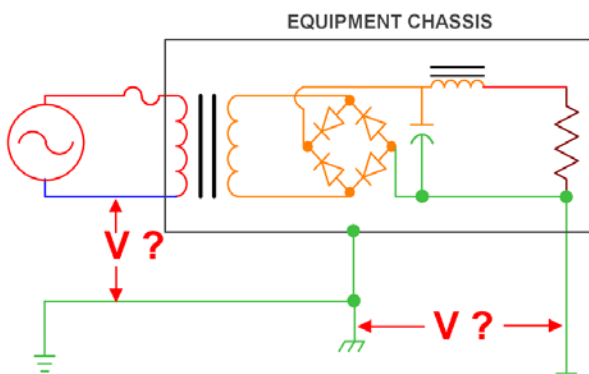



Separate DC Grounding Conductor

- DC grounding tied to main facility grounding
- DC grounding conductor run independent of ac conductors
- Attempt to prevent cross-talk between ac and dc conductors

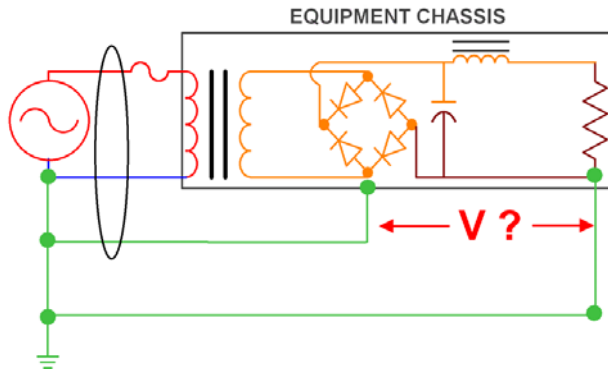

Multiple DC Reference

- Extra dc reference points turns grounding into a dc path
- DC current flows everywhere (inversely proportional to the dc resistance values).

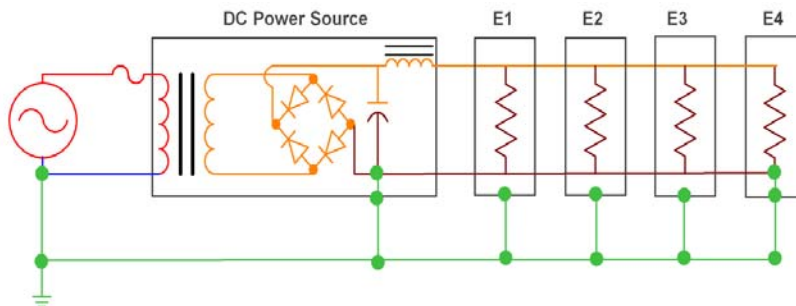



SRG & DC Systems

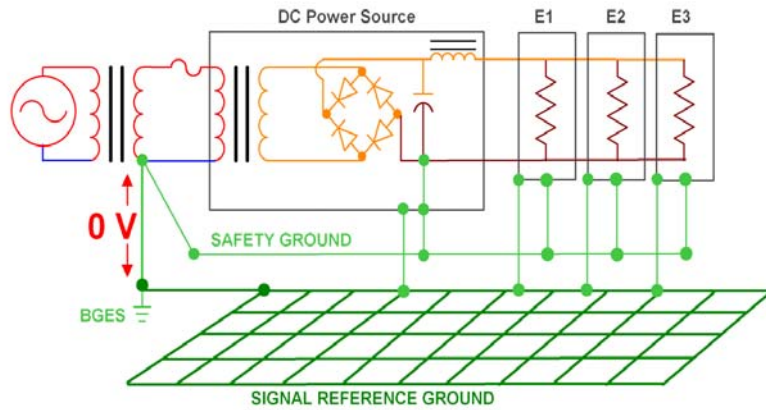

SRG & AC Systems

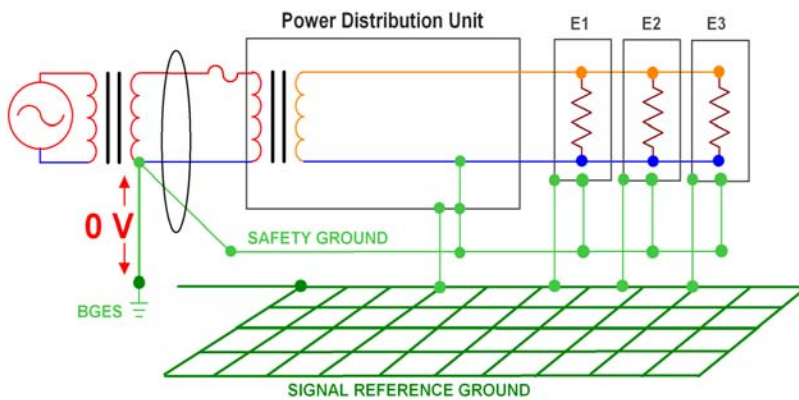



Misapplied SRG

- Attempt to reference equipment independently of facility grounding.
- Violates NEC.
 - SRG not bonded to BGES per NEC 645.
 - SRG serves as sole grounding means independent of SRG.

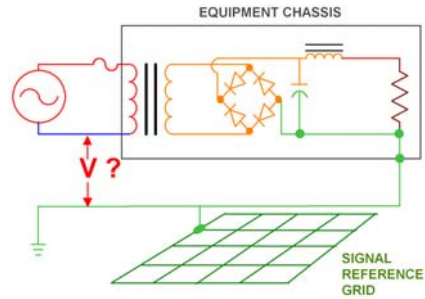

Unwanted Ground Current



Utility Distribution Related

- Stray Current
- Open Neutral
- Interconnected utility neutral and communications grounding
- Coupling to communications circuits



Utility Stray Vs Open Neutral Currents

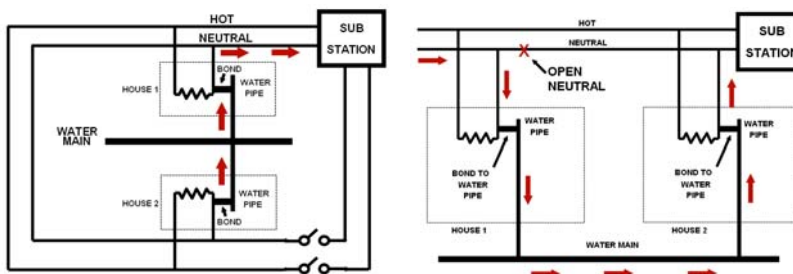



Interconnected Utility Neutrals

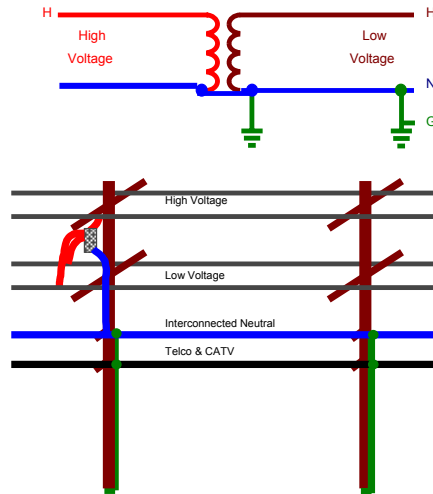

Utility Transformers

▪ L/G Primary



▪ L/L Primary





Facility Related Ground Current

- N/G bonds
- N/G reversals
- Direct use of grounding as a return
- Coupling and induction



Neutral/Ground Bonds

LEGEND:
 - - - Load Current
 ← Neutral Return Current
 EGC = Equipment Grounding Conductor

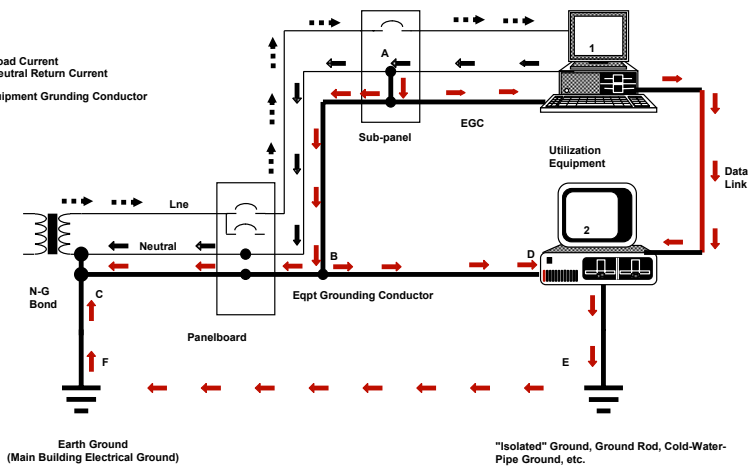



End User Solution to Ground Loops

- Disconnected N/G bond at power distribution unit
- Violates code
- Safety hazard
- Performance problem
- Certainly not the correct solution to a problem

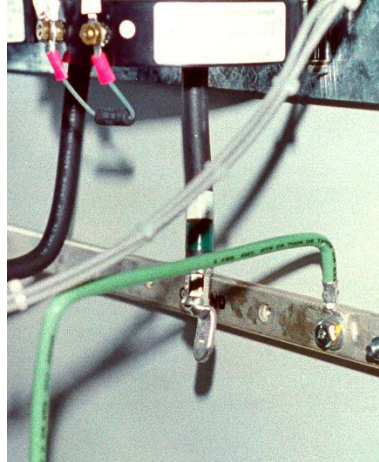

Neutral and Ground Problems

- Crossed neutrals
- N/G reversal

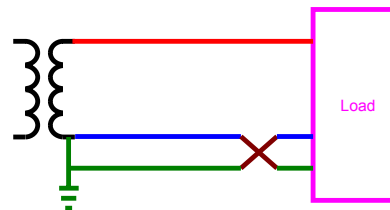
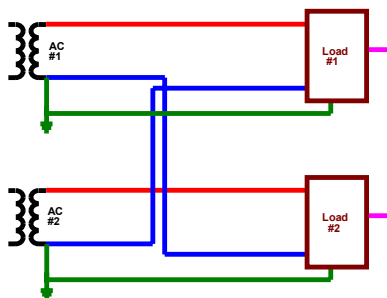



Grounding Conductors & Current

- Grounded conductor problem
- Induced current due to grounded conductor placement

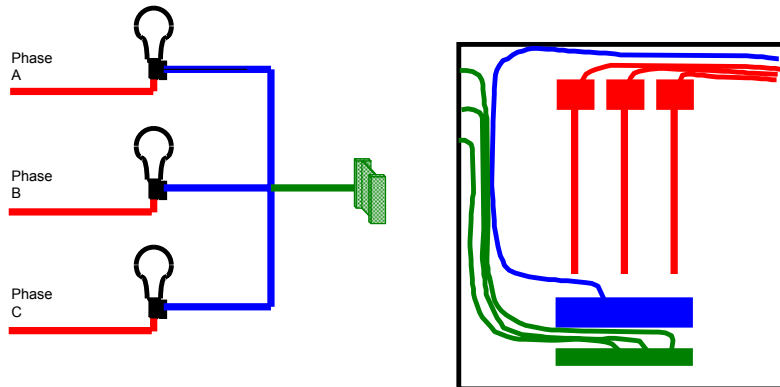

Interference & Ground Loop Measurements

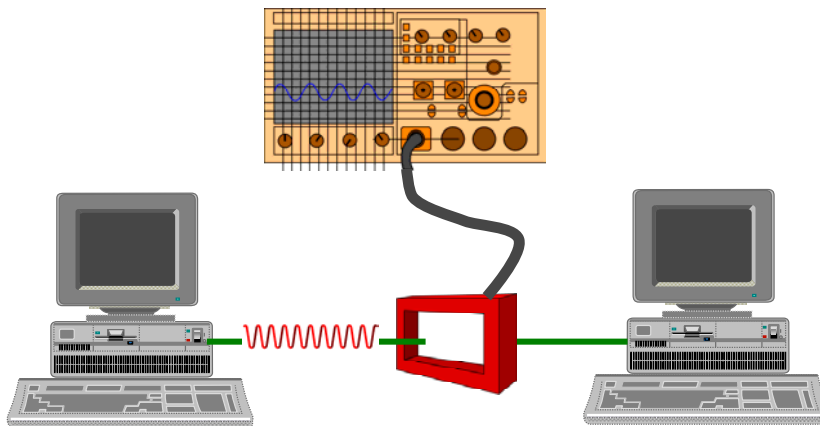



Tracing Ground Currents

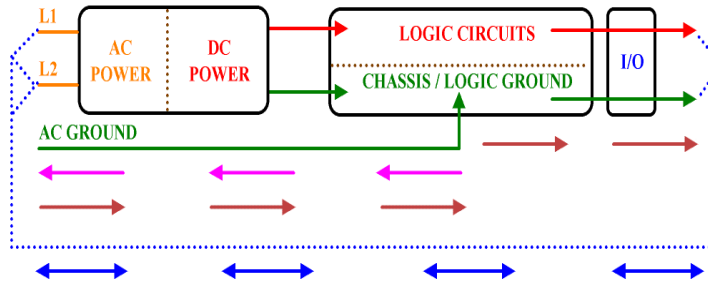

LEAKAGE CURRENTS
 COMMON MODE EMISSIONS
 LONGITUDINAL GROUND CURRENT



Zero Sum Measurements

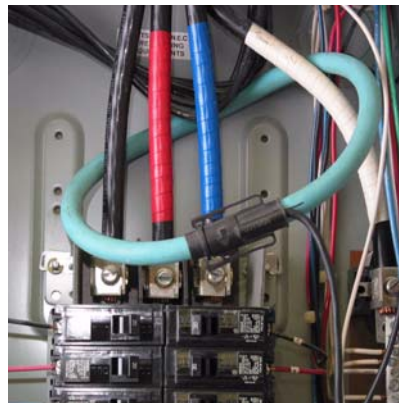
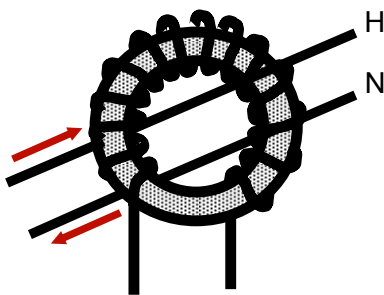



Compare Sum & Neutral



Summing Bus Bars

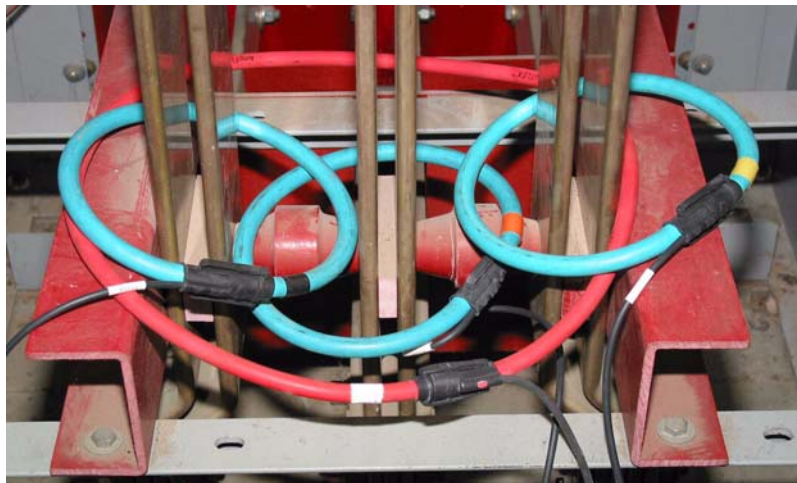



Checking Branch Circuits

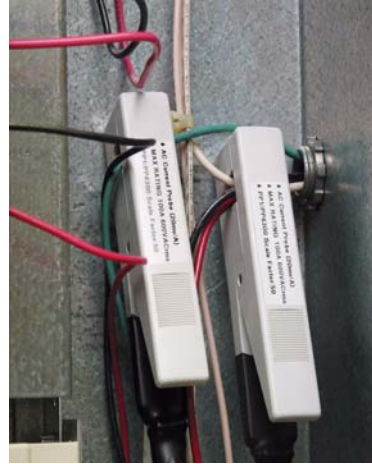

Check Transformers

N/G bond is the ground fault return point
 Current patterns help ID sources

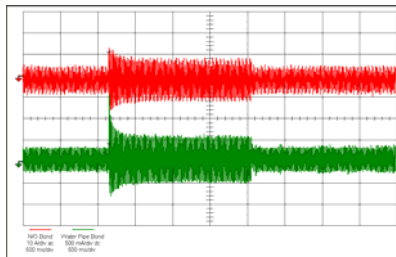



AC Gaussmeter

- Measures flux density
 - Milligauss & MicroTeslas
- Problems arising from flux density
 - CRT waver
 - Induced current flow in data cables
- Great tool to ID ground loops
 - Easy to use
 - Single axis vs triaxial

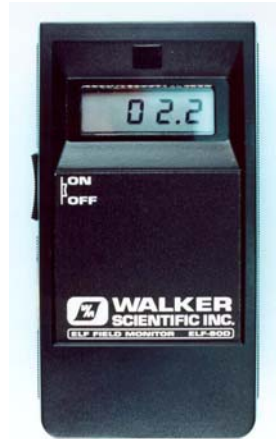

Digital Storage Oscilloscope

- Digitizing rate -- 100MS/s & higher
- Bandwidth -- 100MHz & higher
- Vertical resolution -- 8 bit or better
- Single channel triggering
 - Some scopes may have or-gate triggering on multiple channels
- Single ended signal acquisition
 - Differential measurements require multiple channels or external devices.
- Extended monitoring capabilities
 - Metratek software
 - Stores triggered waveforms & rearms scope
 - DFT of acquired waveforms





High Frequency Measurements

- Everything grounded - interference voltages are small - difficult to distinguish from normal equipment operating noise.
- Currents much larger, easier to measure
- Couple using high-frequency transformer
- Digital storage oscilloscope and spectrum analyzer

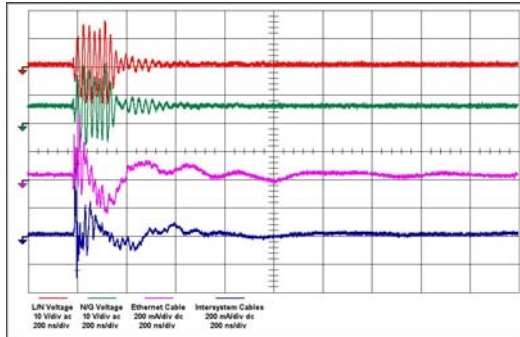

Conventional Current Transformers

- Fluke, AEMC
- Multiple ranges
 - 1mV/A
 - 10mV/A
 - 100mV/A
- Voltage output versus current output





Hall Effect Current Probes

- AEMC, Fluke
- May have multiple ranges
- Provides a proportional voltage output for DC currents
- AC currents can also be recorded
- Requires zero adjustment
- Calibration required



High Frequency CTs

- Commercial products
- Manufacturers
 - EMCO, Tegam, Fischer Custom Communications, Amplifier Research
- Intended use
 - 50 Ohm interface
 - Scopes & spectrum analyzers
- Range
 - 100kHz to 100MHz
 - 1MHz to 1GHz

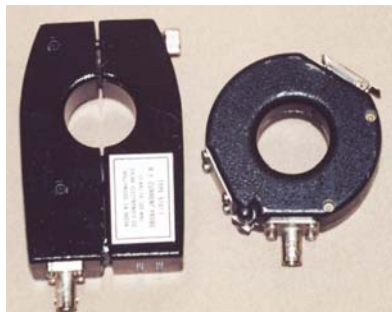



Line Decouplers

- Oneac, PowerVAR
- Depending upon model may have
 - L/N low frequency output
 - High frequency L/N and/or N/G output
 - Bandwidth typically from kHz to low MHz
- Isolates scope from measurement point
- Converts single ended input into differential



Plate Antenna

- Construction
 - Metal top and bottom
 - Plastic sides
 - Probe
 - 10MegOhm – 10x
 - Total capacitance 35pF
 - Intended use
 - Digital storage scopes
 - Record radiated signals, cable potentials, floor potentials





Commercial Loop Antenna

- Manufacturers
 - EMCO, Antenna Research
- Frequency range
 - depends upon model



Ferrite Rod Antennas

- Construction
 - 6" ferrite rod
 - 100 turns of 24 gauge telephone type wire
 - BNC fitting
- Termination provided by scope
- Frequency range
 - 50/60Hz to low kHz





Hioki 3145 Noise Logger

Color LCD Noise Level Display

View instantaneous values of measured noise, and noise level variations over time.



SRG Noise Currents

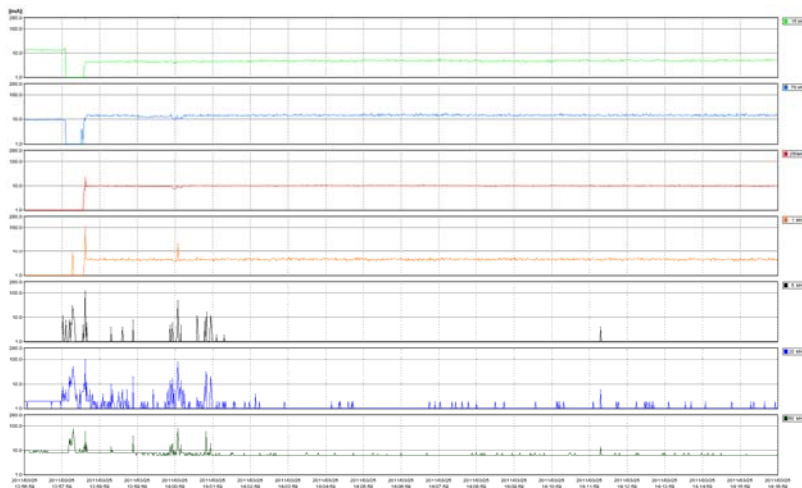



Largest Signal

- Voltage from chassis to plug strip mounted on the cabinet with isolated plastic standoffs.
- Equipment in cabinet mounted on teflon glides.
- Solution was to bond the plug strip to the cabinet.

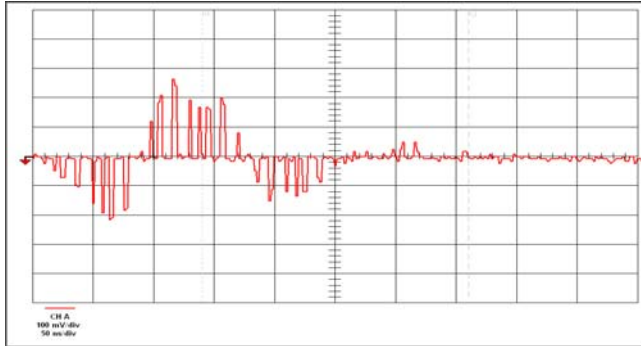

Conclusion



Grounding Items to Avoid

- Supplementary grounding at equipment
 - Parallel to service entrance grounding
- Conduit killers
 - No grounding wire – loose connections
- Needless IG use
 - Grounding bypass of separately derived source
- Grounding "antennas"
 - Daisy chain grounding wires in workstation clusters
 - Lift or defeat data cable shielding of disconnect pin 7 for RS-232-C
- N/G bond removal at transformers to stop ground loops
- Avoid grounding differentials within facilities
 - Control interference at point of origin



Grounding Do's

- Augment service entrance grounding when needed
 - Match the surroundings
- Ensure grounding at wye-to-wye service transformers
- Ensure grounding for padmount transformers inside facilities
- Use parity grounding for branch circuits
- Integrate facility grounding into a "Grounding electrode system"
- Remember Kirchoff's laws
- Use Faraday concept for facility grounding
- Employ reference grids in raised floor environments



Concluding Statements

- Current Flows in Paths - Kirchoff's Laws Prevail
- Ground is a path - not a terminus - and understanding the paths is the key to good grounding
- Interference can compromise good grounding – if something looks ugly – fix it!
- Electrical Codes cannot be compromised by grounding practices